

HA16RTJ - HA16RTJO - HA16RTJ PRO - HA46RTJO - HA46RTJ PRO

Operator's manual

**HA16RTJ - HA16RTJO - HA16RTJ PRO -
HA46RTJO - HA46RTJ PRO**

4000663050

E 05.17

USA / GB



A

FOREWORD

- 1 - User responsibility 8**
 - 1.1- Owner's responsibility 8
 - 1.2- Employer's responsibility 8
 - 1.3- Trainer's responsibility 8
 - 1.4- Operator's responsibility 9
- 2 - Safety 10**
 - 2.1- Safety instructions 10
 - 2.1.1 - Misuse Hazards 10
 - 2.1.2 - Falling Hazards 11
 - 2.1.3 - Overturning / Tip-over Hazards 12
 - 2.1.4 - Electrocution Hazards 15
 - 2.1.5 - Explosion / Fire Hazards 16
 - 2.1.6 - Crushing / Collision Hazards 16
 - 2.1.7 - Uncontrolled movement Hazards 18
- 3 - Safety inquiries 19**
- 4 - Incident notification 19**
- 5 - Compliance 20**
 - 5.1- Product information 20
 - 5.1.1 - Change of Ownership Notification 20
 - 5.1.2 - Owner information update form 21
 - 5.2- Product specifications 22

B

FAMILIARIZATION

- 1 - General safety 23**
 - 1.1- Intended use 23
 - 1.2- Decal content 24
 - 1.3- Symbols and colors 25
 - 1.4- Level of severity 25
 - 1.5- Symbols legend and definitions 26
- 2 - Models description 27**
- 3 - Primary machine components 28**
 - 3.1- Description 28
 - 3.2- Ground control box 30
 - 3.2.1 - Layout 30
 - 3.2.2 - HAULOTTE Activ'Screen 2 33
 - 3.3- Platform control box 52
 - 3.3.1 - Layout 52
 - 3.3.2 - Display Panel (LED'S 101 - 117) 54
- 4 - Performance Specifications 58**
 - 4.1- Technical characteristics 58
 - 4.2- Working area / Range of motion 64
- 5 - Decals and markings locations 66**

CONTENTS



C**PRE-OPERATION INSPECTION**

1 - Recommendations	77
2 - Working area assessment	77
3 - Inspection and Functional test	79
3.1- Daily inspection	79
4 - Safety functional checks	83
4.1- E-Stop button check	83
4.2- Activation of controls	84
4.3- Fault detector	84
4.3.1 - Indicators/LED's test	84
4.3.2 - Buzzers test	85
4.4- Automatic engine cut-out	85
4.5- Overload sensing system (if fitted)	85
4.6- Oscillating axles (if equipped)	86
4.7- Slope warning device	86
4.8- Travel speed limitation	88

D**OPERATION INSTRUCTIONS**

1 - Operation.	89
1.1- Introduction	89
1.2- Operation from the ground control box	89
1.3- Operation from the platform control box	91
1.4- Operation of overriding system from ground control box	92
2 - Ground control box	93
2.1- To start and stop the machine - Diesel engine	93
2.2- To start and stop the machine - Petrol / gas (Propane) Engine	93
2.3- Boom and arm controls	94
2.4- Additional controls	95
3 - Platform control box	96
3.1- To start and stop the machine	96
3.2- To start and stop the machine - Petrol / gas (Propane) Engine	96
3.3- Drive and steer control	97
3.4- Boom and arm controls	98
3.5- Additional controls	99
4 - Emergency procedure	100
4.1- In case of power loss	100
4.2- To rescue operator in platform	101
4.3- No power available	102



CONTENTS

5 - Transportation 103

- 5.1- Putting in transport position 103
- 5.2- Machine layout 104
- 5.3- Unloading 105
- 5.4- Towing 105
- 5.4.1 - Disengaging the drive hubs 105
- 5.4.2 - Re-engaging the drive hubs 106
- 5.5- Storage 106
- 5.6- Lifting operation 107

6 - Cold Weather Recommendations 108

- 6.1- Engine oil 108
- 6.2- Hydraulic oil 109
- 6.3- Preheating operation 110

E

GENERAL SPECIFICATIONS

1 - Machine dimensions 111

2 - Major component masses 113

3 - Acoustics and vibrations 113

4 - Wheel/Tire assembly 114

- 4.1- Technical specifications 114
- 4.2- Inspection and maintenance 114

5 - Options 116

- 5.1- On-board generator 116
- 5.1.1 - Principle 116
- 5.1.2 - Procedure 116
- 5.2- Glazier's kit 117
- 5.2.1 - Description 117
- 5.2.2 - Characteristics 117
- 5.2.3 - Safety precautions 117
- 5.2.4 - Pre-operation inspection 117
- 5.2.5 - Operation 118
- 5.2.6 - Assembly / Dis-assembly 119
- 5.2.7 - Specific decals 120
- 5.3- Activ' Shield Bar - SECONDARY GUARDING SYSTEM (if fitted) 121
- 5.3.1 - Description 121
- 5.3.2 - Characteristics 121
- 5.3.3 - Safety precautions 122
- 5.3.4 - Pre-operation inspection 123
- 5.3.5 - Operation 123
- 5.3.6 - Specific decals 124
- 5.4- Swing gate 125
- 5.4.1 - Description 125
- 5.4.2 - Characteristics 126
- 5.4.3 - Safety precautions 126
- 5.4.4 - Pre-operation instructions 126



F**MAINTENANCE**

1 - General	127
2 - Maintenance Schedule	128
3 - Inspection program	129
3.1- General program	129
3.2- Daily inspection	129
3.3- Periodic inspection	130
3.4- Reinforced inspection	130
3.5- Major inspection	130
4 - Repairs and adjustments	131

G**OTHER INFORMATION**

1 - Warranty disclosure	133
1.1- After Sales Service	133
1.2- Manufacturer's warranty	133
1.2.1- Warranty acceptance	133
1.2.2- Warranty period	133
1.2.3- Procedure conditions	133
1.2.4- Conditions of warranty	134
2 - Subsidiary contact information	136



A - Foreword

A

B

C

D

E

F

G

H

I

You have just purchased a HAULOTTE® product and we would like to thank you for your business.

The Aerial Work Platform is a mechanical device primarily designed and manufactured with the intent to position people with the necessary tools and material to overhead elevated temporary workplaces. All other uses or alterations/modifications to the aerial work platform must be approved by HAULOTTE®.

This manual shall be considered a permanent component of the machine and shall be kept with the aerial work platform in the designated Manual Holder, at all times.

Safe operation of this product can only be assured if you follow the operating instructions contained in this manual. To ensure proper and safe use of this equipment, it is strongly recommended that only trained and authorized personnel operate and maintain the aerial work platform.

We would particularly like to draw your attention to 2 essential points :

- Comply with safety instructions.
- Use the equipment within the specified/published performance limits.

With regard to the designation of our equipment, we stress that this is purely for commercial purposes and not to be confused with the technical specifications. Only the specifications in this manual should be used to study the suitability of the equipment for the intended use.

This operator's manual is specific to the HAULOTTE® products listed on the cover page of this manual.



Original language and version :

Manuals in English and French are the original instructions. Manuals in other languages are translations of the original instructions.

The operator's manual does not replace the basic training required for equipment operators. HAULOTTE® has compiled this manual to assist in safe and efficient operation of the products covered in the manual.

The manual must be available to all operators and must be kept in a legible condition. Additional copies can be ordered from HAULOTTE Services®.

Stay Safe and keep working with HAULOTTE® !

A - Foreword

1 - User responsibility

1.1 - OWNER'S RESPONSIBILITY

The owner (or hirer) has the obligation :

- To inform operators of the instructions contained in the Operator's Manual.
- For applying the local regulations regarding operation of the machine.
- To replace all manuals or decals that are either missing or not legible. Additional copies can be ordered from HAULOTTE Services®.
- To establish a preventive maintenance program in accordance with the manufacturer's recommendations, taking into account the environment and severity of use of the machine.
- To perform periodic inspections in accordance with HAULOTTE® recommendations and local regulations.

All malfunctions and problems identified during the inspection shall be corrected before the aerial work platform is returned to service.

1.2 - EMPLOYER'S RESPONSIBILITY

The employer has the obligation :

- To authorize the operator to use the machine.
- To inform and familiarize the operator with the local regulations.

Forbid anyone from operating the machine if :

- Under the influence of drugs, alcohol, etc.
- Subject to fits, loss of motor skills, dizziness, etc.

1.3 - TRAINER'S RESPONSIBILITY

The trainer must be qualified to provide training to operators in accordance with applicable local regulations. The training must be given in an obstacle-free area until the trainee is considered competent as defined by the training program undertaken.

A - Foreword

1.4 - OPERATOR'S RESPONSIBILITY

The operator has the obligation to :

- Read and understand the contents of this manual and familiarize himself with the decals affixed on the machine.
- To inspect the machine before use according to HAULOTTE®'s recommendations..
- To inform the owner (or hirer) if the manual or any decals are missing or are not legible.
- To inform of any malfunctioning of the machine.

The operator shall ensure that frequent inspections were conducted by the owners and the operator may only operate the machine for the purpose intended by the manufacturer.

Only authorized and qualified operators may operate HAULOTTE® machines.

All operators must become familiar with and fully understand the emergency controls and be able to operate the machine in an emergency.

The operator has the obligation to stop using the machine in the event of malfunction or safety problems on the machine or in the work area and report the problem immediately to his/her supervisor.

A

B

C

D

E

F

G

H

I

A - Foreword

2 - Safety

2.1 - SAFETY INSTRUCTIONS

2.1.1 - Misuse Hazards

- Do not use the machine for any other purpose than to position people, their tools and material to the overhead/elevated temporary work places.
- Do not use the machine as a crane, material lift or elevator. Only use the machine as it was intended.
- Do not attach overhanging loads when raising or lowering the platform.
- Do not tie the boom or platform to an adjacent fixed or mobile structure.
- Do not use/operate the machine when alone. A survey person or immediate Supervisor must be present on the ground in case of emergency.
- Do not use a faulty or poorly maintained machine. Remove defective/damaged machine from service.
- Do not climb onto the compartment covers of the machine.
- Do not replace items critical to machine stability with items of different weight or specification.
- Do not replace factory-installed tires with tires of different specifications or ply rating.
- Do not alter or disable machine components that in any way affect safety and stability.
- Do not disable the safety devices.



A - Foreword

2.1.2 - Falling Hazards

To enter or exit from the platform :

- The machine must be completely stowed.
- Face the machine to access the entry opening to the platform.
- Keep 3 points of contact (both hands and a foot) on the steps and the guardrail.



Before commencing operation :

- Ensure that guard rails are correctly installed and secured.
- Ensure that gate or sliding bar is in its proper closed position.
- Remove oil or grease from the steps, floor, handrail and the guardrails.
- Clear the platform floor free of debris.



When in the platform :

- Occupants must wear a fall arrest harness with lanyard and energy absorber, in accordance with applicable governmental regulations. Attach the lanyard to the designated fall arrest anchor provided in the platform.
- The correct use of the harness requires the lanyard to be connected to an anchorage point designated by the decals. Refer to this decal located on the platform.
- Hold on securely to the guardrails.
- Always keep your feet firmly on the floor of the platform.
- Do not sit, stand, or climb on the platform guard rails.
- Work only within the platform guardrails area and do not lean over guardrails to perform work.
- Do not exit the platform until it is in the completely stowed position.
- Do not use the guardrail as a means of access to climb in or out of the platform.

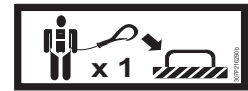

A - Foreword

2.1.3 - Overturning / Tip-over Hazards

Before positioning and operating the machine :

- Ensure that the surface is capable of supporting the machine weight including the rated capacity. Check the load bearing capacity of the supporting ground.
- Remain vigilant of driving direction reversal at the platform. Check the driving direction with the help of the red or green arrow on the chassis relative to the red and green arrows on the platform control box.
- Do not exceed the maximum rated capacity that includes the weight of both material and allowed number of occupants. Do not exceed the allowable number of occupants.
- Place the loads uniformly distributed on the platform floor.
- Do not increase the working height (using extensions, ladder, etc.).
- Do not place ladders or scaffolds in the platform or against any part of this machine.
- Do not use the machine in winds exceeding the permissible limit.
- Do not increase the surface area of the platform exposed to wind. This includes adding panels, mesh, banners. Be aware when working with materials with a large surface area. This will add to the wind load on the machine.
- Do not raise the platform or drive with platform elevated on an incline exceeding the rated slope for the machine.
- Do not drive the machine on slopes or grades exceeding the specified limits.
- Do not replace components critical to stability with components of different weight or specification.
- Do not use the machine with material or objects hanging from the guardrail or the boom.
- Do not pull or push towards any object outside of the platform. Do not exceed the maximum allowable side force stated in the performance specifications.
- Do not use the machine to support any external structure.
- Do not use the machine to tow other machines or to drag materials.



A - Foreword

Using a machine on a slope :



Do not exceed the slope limit for each operation.  Section B 4.1 Technical specifications.

Slope :

- Drive in transport position on an upward or downward slope.

Sideslope :

- Driving in stowed position across a slope.

Rated slope :

- Operating with platform elevated.

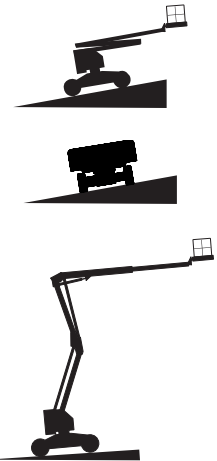

- If the tilt alarm sounds with the platform uphill : Retract the boom, lower the arm and then lower the boom.
- If the tilt alarm sounds with the platform facing downhill : Lower the boom, lower the arm and then retract the boom.
- While driving, always place the boom above the rear axle, in the direction of movement.
- **While driving on a slope:**
 - Always orientate the machine in the direction of the slope.
 - Always place the boom in fully retracted and in stowed position.
 - Do not travel down slopes in high speed.
 - Do not drive fast in narrow or cluttered areas. Keep speed under control while making turns or sharp bends.

WIND : The aerial work platform can operate up to a maximum wind speed as indicated in the specifications. To identify the local wind speed, use the Beaufort scale below, use a wind gauge or an anemometer.

A - Foreword

N.B.:-THE BEAUFORT SCALE OF WIND FORCE IS ACCEPTED INTERNATIONALLY AND IS USED WHEN COMMUNICATING WEATHER CONDITIONS. A WIND SPEED RANGE AT 10 M (32 FT 9 IN) ABOVE FLAT, CLEAR LAND IS ASSOCIATED WITH EACH DEGREE.

Beaufort scale

Force	Meteorological description	Observed effects	m/s	km/h	mph
0	Calm	Smoke rises vertically.	0 - 0,2	0 - 1	0 - 0,62
1	Very light breeze	Smoke indicates the wind direction.	0,3 - 1,5	1 - 5	0,62 - 3,11
2	Light breeze	Wind felt on the face. Leaves rustle. Weather vanes turn.	1,6 - 3,3	6 - 11	3,72 - 6,84
3	Slight breeze	Leaves and small twigs in constant motion. Flags move slightly.	3,4 - 5,4	12 - 19	7,46 - 11,8
4	Nice breeze	Raised dust and loose papers. Small branches are moved.	5,5 - 7,9	20 - 28	12,43 - 17,4
5	Nice breeze	Small trees in leaf to sway. Crested wavelets form on inland waterways.	8,0 - 10,7	29 - 38	18,02 - 23,6
6	Cool wind	Large branches in motion. Power lines and chimneys 'sing'. Umbrellas used with difficulty.	10,8 - 13,8	39 - 49	24,23 - 30,45
7	Near gale	Whole trees in motion. Inconvenience felt when walking against wind.	13,9 - 17,1	50 - 61	31 - 37,9
8	Squall	Some branches break. Generally we cannot walk against the wind.	17,2 - 20,7	62 - 74	38,53 - 45,98
9	Strong squall	The wind causes slight damage to buildings. Tiles and chimney stacks are blown off.	20,8 - 24,4	75 - 88	46,60 - 54,68

A - Foreword

2.1.4 - Electrocutation Hazards

The machine is not electrically insulated and does not provide protection from contact or proximity to electrically charged conductors.

Always position the lift at a safe distance from electrically charged conductors to ensure that no part of the machine is within an unsafe area.

Respect the local rules and the minimum safety distance from power lines.

Minimum safe approach distances

Electric voltage	Minimum safety distance	
	Mètre	Feet
0 - 300 V	Avoid contact	
300 V - 50 kV	3	10
50 - 200 kV	5	15
200 - 350 kV	6	20
350 - 500 kV	8	25
500 - 750 kV	11	35
750 - 1000 kV	14	45

N.B.-:USE THIS TABLE EXCEPT WHERE LOCAL REGULATIONS INDICATE OTHERWISE.

- Do not operate the machine when close to live power lines, consider the movement of the machine and the sway of the electric power lines particularly in windy conditions.
- Do not operate the machine during lightning, thunderstorms, snow/ice or any weather condition that could compromise operator safety.
- Do not use the machine as a ground for welding.
- Do not weld on the machine without first disconnecting the battery terminals.
- Always disconnect ground cable first.
- The machine must not be used while charging the batteries.
- When using the platform AC power supply, ensure it is protected with a circuit breaker and residual current device.

Keep away from the machine if it contacts energized power lines. Personnel on the ground or in the platform must not touch or operate the machine until energized power lines are shut off.



A - Foreword

2.1.5 - Explosion / Fire Hazards

Always wear protective clothing and eye wear when working with batteries and power sources/systems.

N.B.:-ACID IS NEUTRALIZED WITH SODIUM BICARBONATE AND WATER.

- Do not start the engine if you smell or detect liquid propane gas (LPG), gasoline, diesel fuel or other explosive substances.
- Do not work on or operate a machine in an explosive or flammable atmosphere / environment.
- Do not touch hot components.
- Do not bridge the battery terminals with metallic objects.
- Do not service the battery in proximity of spark, open flame, lit cigarettes.
- Do not fill up the fuel tank, when the engine is running and/or near a flame.



2.1.6 - Crushing / Collision Hazards

When in the platform :

- Check the work area for overhead clearance, for any obstacles besides and below the platform when raising/lowering the platform and or before driving.
- During movement, keep all the parts of the body inside the platform. Hold onto the guardrails on the opposite side to any surrounding structures. Take care to avoid trapping hands whilst holding the guardrails.
- To position machine close to a building/structure, it is recommended using the upper boom and or arms movement control functions to position, rather than driving machine closer to structure.
- Always cordon off the area around the base of the machine to keep personnel and other equipment away from the machine while in use.
- Warn personnel not to work, stand, or walk under a raised boom/platform.
- Do not drive in reverse direction (opposite the field of vision).
- Be aware of the boom position and tail swing when rotating the turret (turntable).
- Always ensure that the chassis is never driven any closer than 1 m (3 ft 3 in) to holes, bumps, slopes, obstructions, debris and ground coverings that may hide holes and other dangers.
- Keep non-operating personnel at least 5 m (16 ft 5 in) away from the machine when driving and slewing.

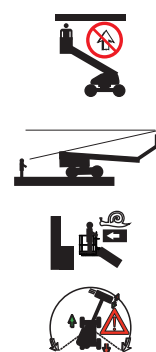

A - Foreword

- Be aware of driving direction.
 - When turret is slewed/rotated 180°, the platform is now facing the rear of the machine.
 - Check the driving direction with the help of the red or green arrow on the chassis relative to the red and green arrows on the platform control box.
 - Also note that when changing the driving direction (Forward <> Reverse) the joysticks or switches must return to the neutral position before reversing the drive direction and for movement to occur.
- When driving, position the platform so as to provide the best possible visibility and to avoid any blind spots.
- Hold on securely to the guardrails.
- Occupants must wear a fall arrest harness with lanyard and energy absorber, in accordance with applicable governmental regulations. Attach the lanyard to the designated fall arrest anchor provided in the platform.
- Avoid contact with fixed or mobile obstacles (other machines).
- Other machines (crane, aerial work platform, etc.) operating in the work area increase the risk of crushing or collision. Restrict the operation of machines moving within the aerial work platform work area.
- Take into consideration the stopping distance, reduced visibility and blind spots of the machine.
- Limit travel speed to suit the ground surface condition, slope (incline), and people in the vicinity.

A

B

C

D

E

F

G

H

I

A - Foreword

2.1.7 - Uncontrolled movement Hazards

Do not use a damaged or malfunctioning machine.

Be aware of uncontrolled movement and always respect the following :

- Maintain clearance from high voltage lines.
- Maintain clearance from generators, radar, electromagnetic fields.
- Never expose the batteries or electrical components to water (high pressure washer, rain).
- Never tow the machine over extended distances.
- In case of a machine breakdown, it is possible to tow short distance to load it onto a trailer.
- Never leave the hydraulic cylinders fully extended before switching off the machine, or when stationary for an extended period of time.
- Retract the boom and lower the arms to the stowed position.
- Rotate the turntable so that the boom is between the non-steering wheels.
- Select a safe parking location, on a firm level surface, clear of obstruction and traffic.
- Ensure all compartments are closed and secured.
- Chock the wheels.
- Operator must remove the foot from the footswitch when any movement has ceased.

A - Foreword

3 - Safety inquiries

Inquiries relating to design criteria/specifications of a product, standards compliance, or overall machine safety should be sent to the HAULOTTE® PRODUCT SAFETY department.

Each inquiry or request should include all relevant information; including contact name, telephone number, mailing address, email address, plus the machine model and serial number.

The HAULOTTE® Product Safety department will evaluate each request/inquiry and will provide a written response.

4 - Incident notification

Notify HAULOTTE® immediately when a HAULOTTE® product has been involved in an incident/accident leading to personal injury or death, or when there is a major property damage.

HAULOTTE Group - EUROPE Product Safety Department	HAULOTTE Group - Australia, India and Asia Product Safety Department	HAULOTTE Group - North & South America Product Safety Department
Address : La Péronnière - BP 9 - 42152 L'Horme - France	Address : No.26 Changi North Way - Singapore 498812 - Singapore	Address : 3409 Chandler Creek Rd. - Virginia Beach, VA 23453 - United States
Tel : +33 (0)4 77 29 24 24	Tel : +65 6546 6150	Tel : +1 757 689 2146
Email : ProductSafety@haulotte.com	Email : ProductSafety@haulotte.com	Email : ProductSafety@haulotte.com

A - Foreword

5 - Compliance

5.1 - PRODUCT INFORMATION

Without the written permission from Haulotte, modifying a HAULOTTE® product is a Safety concern. Any modification may violate Haulotte design parameters, government regulations and industry standards.

If you desire a modification to the product, submit a request in writing to HAULOTTE®.

With the utmost care to ensure enhanced reliability and greater safety of the HAULOTTE® products, it is pertinent that when a "Service or Safety Bulletin" is issued, action is taken immediately. Once the bulletin has been addressed, make sure that the completed form is submitted to HAULOTTE®.

Do not hesitate to contact HAULOTTE Services®, should you have any questions relating to the issued bulletin(s) or with questions on the policy itself.

5.1.1 - Change of Ownership Notification

It is important and necessary to keep HAULOTTE Services® updated with current ownership of the machine. This way, HAULOTTE® will be able to provide the necessary support for the product. If you have sold or transferred this machine(s); it is your responsibility to notify HAULOTTE Services®. It is not required to include Lessees/Renters of Leased/Rented machines on this form.

Use the HAULOTTE® Product Status Notification form to report scrapped, stolen, missing or recovered machine(s).

A - Foreword

5.1.2 - Owner information update form

Owner information update form

Complete this form and mail or fax it to :

HAULOTTE® subsidiary Name :

Address 1 :

Fax :

Address 2 :

e.mail address :

Address 3 :

Product information :

Model :

Machine serial number :

Owner / Servicing information :

Do not include leased or rented units in this form

Current product owner 1 :

Current product owner 2 :

Name :

Name :

Company :

Company :

Address 1 :

Address 1 :

Address 2 :

Address 2 :

Country :

Country :

Phone :

Phone :

Date of ownership :

Date of ownership :

Signature :

Signature :

Date :

Date :

Company stamp is mandatory :

Company stamp is mandatory :

Tick here if the machine has been permanently removed from service (scrapped). The manufacturer's nameplate must be removed and returned to HAULOTTE Group when the unit is removed from service.

Reason for removal :

A - Foreword

5.2 - PRODUCT SPECIFICATIONS

HAULOTTE® cannot be held liable for any changes to the technical characteristics/specifications contained in this manual. HAULOTTE® has a continuous improvement policy in place for its product range; given this policy, the Company reserves the right to modify their products technical characteristics / specifications without notice.

Certain options can modify the machine's operating characteristics and its' associated safety. If your machine was originally delivered with options fitted, replacing a safety component associated with a particular option does not require any particular precaution other than those associated with the installation itself (static test).

Otherwise, it is essential to follow the manufacturer's recommendations as stated below :

- Installation by authorised HAULOTTE® personnel only.
- Update the manufacturer's identification plate.
- Have stability tests carried out by a certified agency/competent person.
- Ensure decals are updated.

B - Familiarization

1 - General safety

1.1 - INTENDED USE

To ensure the safe use of an Aerial Work Platform, support personnel must always be available on the ground. If necessary, support personnel will be required to operate the emergency functions of the machine and in rescuing the operator.

Do not operate the product in the following situations :

- On soft, unstable or cluttered ground.
- With wind blowing faster than the permissible limit.
 - Check the allowable wind speed specified in the performance specifications tabulation.
 - Consult the Beaufort scale.
- Close to power lines. Keep a safe distance.
- Outside of the temperature range -20°C / $+50^{\circ}\text{C}$ (-4°F / $+122^{\circ}\text{F}$).
- In an explosive atmosphere / environment.
- During storms.
- In the presence of strong electromagnetic fields.

N.B.-:USE THE MACHINE UNDER "NORMAL" CLIMATIC CONDITIONS. IF YOU NEED TO USE THE MACHINE IN CLIMATIC CONDITIONS LIKELY TO CAUSE DETERIORATION (EXTREME : HUMIDITY, TEMPERATURES, SALINITY, CORROSIVENESS, ATMOSPHERIC PRESSURE), CONTACT HAULOTTE SERVICES®. REDUCE INTERVALS BETWEEN SERVICING.

N.B.-:WHILE THE MACHINE IS NOT IN USE, CARE MUST BE TAKEN TO BRING THE MACHINE TO THE FULLY STOWED POSITION. ENSURE THAT THE MACHINE IS LOCKED IN A SECURE LOCATION, AND THE CONTROL KEY IS REMOVED TO PREVENT UNAUTHORISED USE OF THE MACHINE.

B - Familiarization

1.2 - DECAL CONTENT

Decals are provided to alert the user of hazards inherent with the Aerial Work Platforms.

Decals provide the following information :

- The level of severity.
- The specific hazard.
- A method to avoid, suppress or reduce the hazard.
- Descriptive text (where required).

Familiarize yourself with the decals and the hazard severity levels.

CE and AS standards



ANSI and CSA standards



Marking	Description
1	Hazard symbol
2	Level of severity
3	Avoidance symbol pictorial
4	Avoidance text

Decals must be kept in good legible condition.

Familiarize yourself with the decals and their respective color codes.







Additional decals can be ordered from HAULOTTE Services®.

B - Familiarization











1.3 - SYMBOLS AND COLORS

Symbols and colors are used to alert the operator of safety precautions and/or to highlight important safety information.

The following safety symbols are used throughout this manual to indicate specific hazards and the hazard severity level when operating or maintaining the Aerial Work Platform.

Symbol	Description
	Danger : Risk of injury or death
	Caution : Risk of material damage
	Prohibited action
	Reminder to use good practice or follow pre-operation checks
	Cross-reference to another part of the manual
	Cross-reference to another manual
	Cross-reference to repair (contact HAULOTTE Services®)
N.B. :	Additional technical information

1.4 - LEVEL OF SEVERITY



































Color	Title	Description
		Danger : Indicates a hazardous situation which if not avoided, WILL result in death or serious injury.
		Warning : Indicates a hazardous situation which if not avoided, COULD result in death or serious injury.
		Caution : Failure to comply could result in minor or moderate injury.
		Notice : Indicates recommended practices if not followed, may result in a malfunction or damage the machine or its components.
		Procedure : Indicates a maintenance operation.

B - Familiarization

1.5 - SYMBOLS LEGEND AND DEFINITIONS

Symbols are used throughout this manual to depict hazards, avoidance measures and indicate when information is required.

Refer to the following table to familiarize yourself with these symbols.

Symbol	Description	Symbol	Description	Symbol	Description
	Body crushing hazard		Foot crushing hazard		High pressure fluid ejection hazard
			Hand crushing hazard		Entanglement hazard
			Health/safety hazards related to chemicals		Health-damaging effects from hot work environment
	Electrical contact or lightning strike		Burns and scalds from contact with flames, explosion or radiation from heat sources		Injury from Electric arcs - Energy supply disconnecting devices - Batteries fire, emissions, etc
	Risk of operator(s) falling		Tip over due to excessive loading / wind load and excessive ground slope		Relate and coordinate directional arrows on the chassis with those on the control box
	Do not put foot in this area		Do not put your hand in this area		Keep away from product working area
	Never expose batteries and electrical component to high pressure washer		Ensure entry drop rail is down		Maintain safe clearance from high voltage electrically charged conductors as described in manual - Do not use in thunderstorms
	Flames prohibited		Safety belt		Overload
	Refer to operator manual		Enable switch		Use appropriate lanyard attached to dedicated anchor point.
	Wheel pressure		Tie down point		Use safety prop before attempting any maintenance work
	Tow point		Wear protective equipment		Lift point
	Keep away from hot surfaces				

B - Familiarization

2 - Models description

Regulation	Models
ANSI and CSA standards	HA46RTJO
	HA46RTJ PRO
CE, AS and EAC standards	HA16RTJ
	HA16RTJO
	HA16RTJ PRO

B - Familiarization

3 - Primary machine components

3.1 - DESCRIPTION

HA16RTJ - HA16RTJ O - HA16RTJ PRO - HA46RTJ O - HA46RTJ PRO

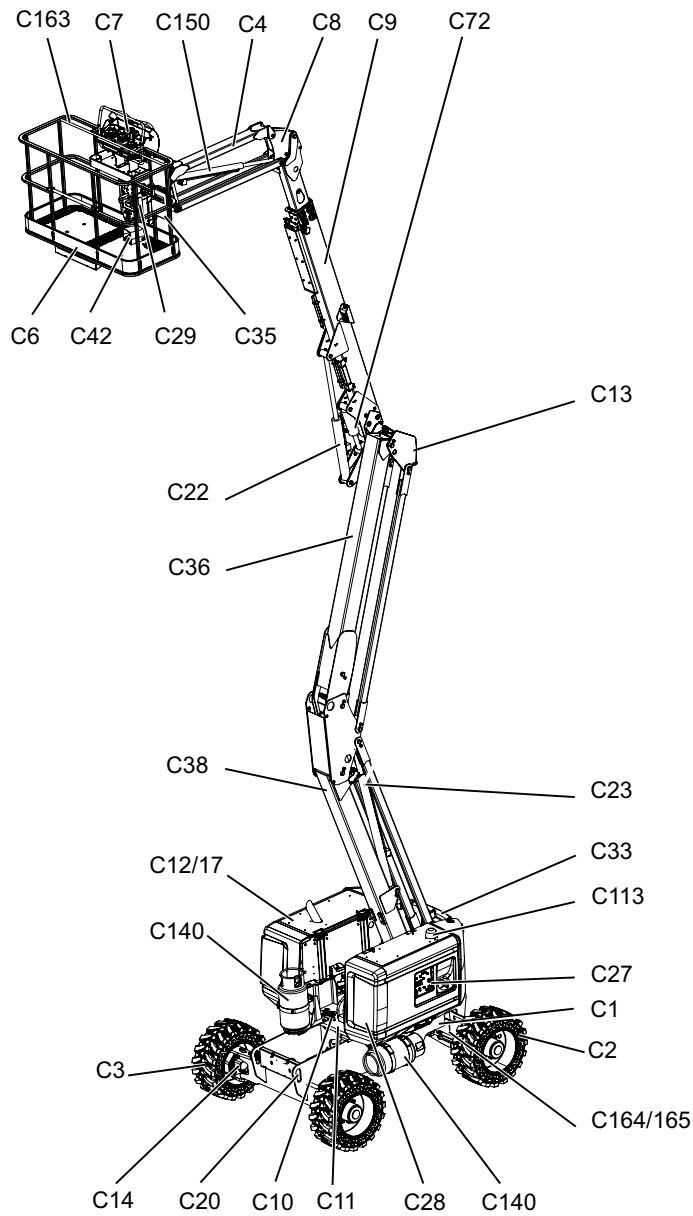

B - Familiarization

Marking	Description	Marking	Description
C1	Chassis	C23	Arm lifting cylinder
C2	Front driven steering axle	C27	Ground control box
C3	Rear drive wheel (and steer wheel if 4WS)	C28	Tilt sensor
C4	Jib	C29	Platform rotation cylinder
C6	Platform	C33	Counterweight
C7	Platform control box	C35	Document holder
C8	Input jib compensation cylinder	C36	Top arm
C9	Upper boom	C38	Bottom arm
C10	Slew ring	C42	'Enable Switch' pedal
C11	Turntable assembly	C72	Output jib compensation cylinder
C12	Right side compartment	C113	Beacon light
C13	Arm/Boom link piece	C140	Propane bottles - (For ANSI / CSA standard only)
C14	Hydraulic drive motor and reducer	C150	Jib lifting cylinder
C17	Left side compartment (engine, pump and starter battery)	C163	Handrail
C20	Tie-down (and/or lifting) points	C164	Front steering axle
C22	Boom lift cylinder	C165	Front steering and oscillating axle (For HA16RTJO / HA16RTJPRO / HA46RTJO / HA46RTJPRO only)

B - Familiarization

3.2 - GROUND CONTROL BOX





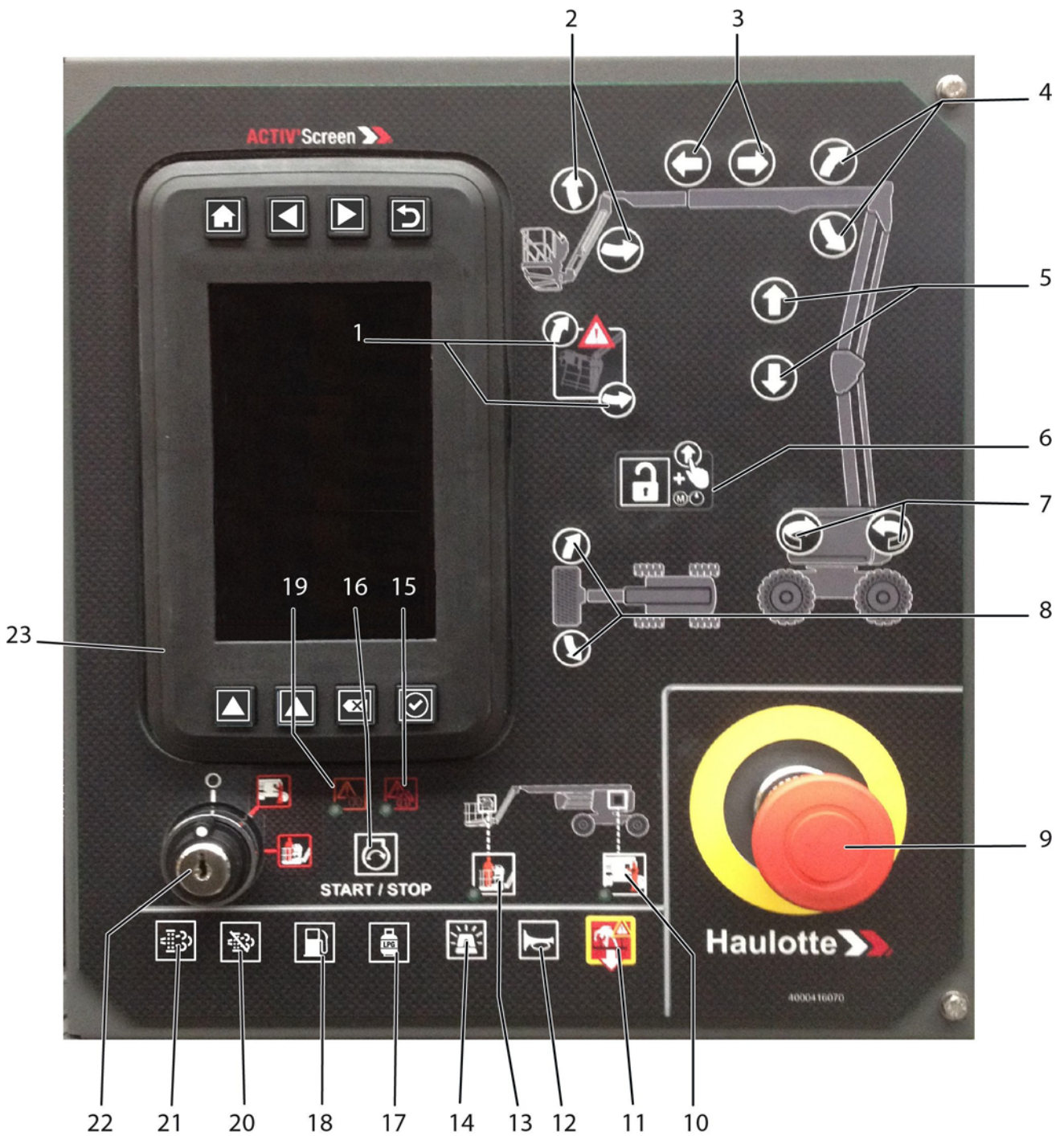











3.2.1 - Layout

General view













B - Familiarization

Controls and indicators

Marking	Description	Function
1	Putting in transport position selector	By pressing on  : Machine in use position
		By pressing on  : Machine in transport position
2	Jib lifting / lowering switch ¹	By pressing on  : Jib lifting
		By pressing on  : Jib lowering
3	Boom telescoping switch	By pressing on  : Boom extend
		By pressing on  : Boom in
4	Boom raising switch	By pressing on  : Boom raising
		By pressing on  : Boom lowering
5	Arm lifting switch	By pressing on  : Arm raises
		By pressing on  : Arm lowers
6	'Enable Switch' selector / Back-up unit selector	By pressing on  : <ul style="list-style-type: none"> • Validation of controls when engine started • automatic switching of emergency electropump if the engine is stopped
7	Turntable rotation switch	By pressing on  : Counter clockwise (CCW) rotation
		By pressing on  : Clockwise (CW) rotation
8	Platform rotation switch	By pressing on  : Clockwise (CW) rotation
		By pressing on  : Counter clockwise (CCW) rotation
9	E-stop button	Pulled out : Ground control box energized Pushed in (activated) : De-energizes control system
10	Indicator of the ground control box selection	LED lights up - ground control box icon
11	"Overriding system" control	By pressing on  : This should be used ONLY when normal operation from the ground box is unavailable - use in emergency ONLY
12	Horn button	By pressing on  : Horn activation

B - Familiarization

Marking	Description	Function
13	Indicator of the platform control box selection	LED lights up - platform control box icon
14	Beacon light on/off	By pressing on  : Beacon light ON / OFF
15	Overload indicator / Fault	Alarm icon  : <ul style="list-style-type: none"> • Is ON at power up of the machine, at the same time as the icon (19) • Is blinking if overriding is active : • An active or detected failure is displayed on on-board screen • Or Hydraulic oil temperature icon is active on on-board screen • Or Engine pressure icon is active on on-board screen • Or Engine stop icon is active on on-board screen • Or Overload machine status is active on on-board screen
16	Engine start-up selector	By pressing on  : Engine start / stop
17	Propane Gas supply ²	By pressing on  : Propane Gas supply selection
18	Petrol/Gasoline or diesel supply ³	By pressing on  : Fuel supply selection
19	Engine warning indicator / Engine pre-heating	Alarm icon  : <ul style="list-style-type: none"> • Is ON at power up of the machine at the same time as the icon (15) • Is blinking if overriding is active Warning icon is ON if : • Engine warning icon is active on on-board screen • Or Tilt machine status is active on on-board screen • Or Engine is pre-heating
20	DPF regeneration inhibited ⁴	By pressing on  : Refusal of the request for regeneration
21	DPF regeneration required ⁵	By pressing on  : Regeneration start-up
22	Control box activation key selector	 : De-energizes control system
		 : Platform control box energized
		 : Ground control box energized
23	Activ'Screen 2	

1. For machines fitted with
 2. For machines fitted with
 3. For machines fitted with
 4. For machines fitted with
 5. For machines fitted with

B - Familiarization

3.2.2 - HAULOTTE Activ'Screen 2

Upon starting and during operation of the machine, the LCD screen "Activ'Screen" located on the ground control box displays in real time the machine operating status.

HAULOTTE Activ'Screen 2

Icon	Description	Function	Icon	Description	Function
------	-------------	----------	------	-------------	----------

HAULOTTE Activ'Screen 2





Navigation buttons - Above Activ'Screen display

	Home Button	Allows return to the home screen at any time		Up Navigation	Permits scrolling up through the screen (if present)
	Left navigation	Permits navigation to screens to the left (if present)		Down Navigation	Permits allows scrolling down through the screen and onto the following screen (if present)
	Right Navigation	Permits navigation to screens to the right of the current screen (if present)		Cancel Button	Used to refuse or cancel a selection within the menu
	Back button	Returns the user to the previous screen		Validation Button	Used to confirm selection within the menus

B - Familiarization









On initial start-up of the machine or after 3 day of inactivity, the following screens are displayed in order.

Controls and indicators

Icon	Description	Function	Icon	Description	Function
Machine power up (Start-up screen)					
					
					

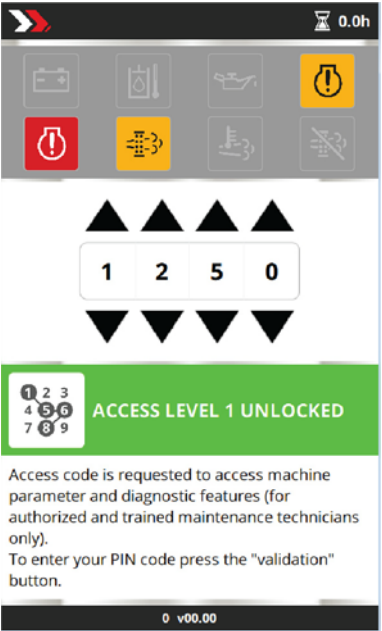



B - Familiarization

Controls and indicators

Icon	Description	Function	Icon	Description	Function
	Access code is requested to access machine parameter and diagnostic features - for authorized and trained maintenance technicians only. Press "enter" to start. Then use "up" and "down" + "enter" buttons to enter the code.	Access code (Will be visible - depending on the machine)		Access code not yet entered	
				Access code entered is correct (Level 1, 2 or 3 depending on autorisation of technician)	
				Access code entered is incorrect	
	Access code is requested to access machine parameter and diagnostic features (for authorized and trained maintenance technicians only). To enter your PIN code press the "validation" button.	Access code NIV 1 (Will be visible - depending on the machine)		Operator PIN code not yet entered	
				Operator PIN code entered is correct	
				Operator PIN code entered is incorrect	

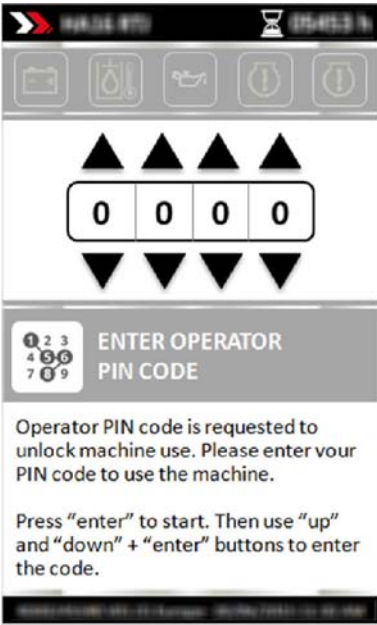





B - Familiarization

Controls and indicators

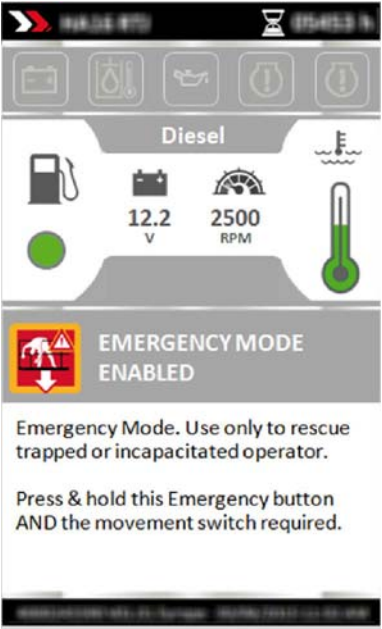
Icon	Description	Function	Icon	Description	Function
		Operator PIN code (Will be visible - depending on the machine)		ONBOARD DIAGNOSTIC ACCESS	Operator PIN code not yet entered
				ACCESS LEVEL 2 UNLOCKED	Operator PIN code entered is correct
				WRONG ACCESS CODE	Operator PIN code entered is incorrect

B - Familiarization

Controls and indicators

Icon	Description	Function	Icon	Description	Function
	Platform control box E-stop button			UPPER EMERGENCY STOP ACTIVATED	E-Stop at platform control box has been pushed in (de-energized). The machine will switch off after several seconds. In an emergency, use this mode.
	Emergency mode			EMERGENCY MODE ENABLED	Emergency mode is activated when : <ul style="list-style-type: none"> • The E-Stop at platform control box is pushed in (de-energized). • The machine is in overload state. • Ground control box is selected/energized. • The emergency overriding button is activated.
				EMERGENCY MODE NOT ACTIVE	Emergency mode is deactivated when : <ul style="list-style-type: none"> • The E-Stop at platform control box is pulled out (energized). • The machine is NOT in overload state. • Ground control box is NOT selected/energized.
				EMERGENCY MODE NOT ACTIVE	The Emergency mode is out of service/non-functional
				EMERGENCY EVENT HAS OCCURED	Emergency mode has been used and activation of its function saved in the memory of the machine. A HAULOTTE® certified technician is required to reset the Emergency Mode system.

A

B

C

D

E

F

G

H

I

B - Familiarization

Controls and indicators

Icon	Description	Function	Icon	Description	Function
------	-------------	----------	------	-------------	----------

**Home screen (dashboard)
(Will be visible - depending on the machine)**

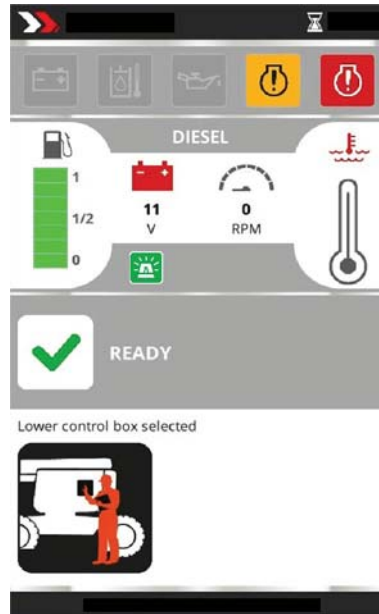

	Machine model zone		Machine Model	<ul style="list-style-type: none"> Machine model display
	Hour meter/next maintenance zone		Hourmeter	<ul style="list-style-type: none"> The timer flashes if the engine is switched on and the hourmeter increases.
	Maintenance use	<p>The Maintenance Tool icon and the number of hours remaining until the next maintenance are displayed for 5 seconds when the machine is started up. Maintenance Tool icon blinks; if maintenance is due.</p> <p>The maintenance tool icon turns RED when the next scheduled maintenance must be carried out in under 25 hours.</p>		

B - Familiarization

Controls and indicators

Icon	Description	Function	Icon	Description	Function
------	-------------	----------	------	-------------	----------



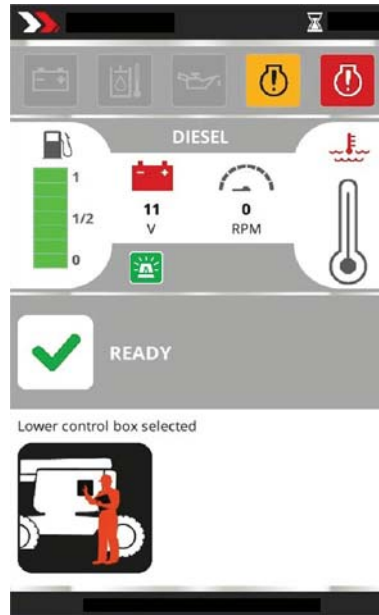



Home screen (dashboard)
(Will be visible - depending on the machine)

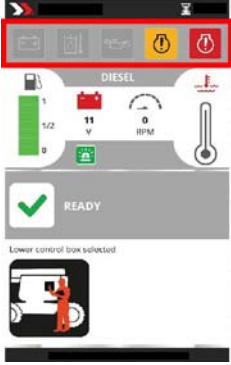

	Warning icons zone		Battery State	<ul style="list-style-type: none"> Icon is ON if there is no charge output detected from the alternator Icon is flashing if a failure code for the alternator is detected (code F09.10)
			Hydraulic oil temperature	Icon is ON when the temperature in the hydraulic reservoir has exceeded the maximum required temperature. Stop using the machine and allow the oil to cool down.
			Engine oil pressure	Icon is ON if engine oil pressure is lower than required limit while engine is running. The Engine must be switched OFF immediately to avoid damaging the motor.
			Engine oil level	<ul style="list-style-type: none"> The engine oil level is under the acceptable limit for correct engine operation. Top up the oil level.
			Stop motor	<ul style="list-style-type: none"> Icon is ON if an engine failure is detected (coolant, pressure, alternator etc) Or if the Engine shuts down after 3 seconds of running. Or after 1 second when engine fails to start.



B - Familiarization

Controls and indicators

Icon	Description	Function	Icon	Description	Function
Home screen (dashboard) (Will be visible - depending on the machine)					
 <p>Warning icons zone</p>				Engine warning	<ul style="list-style-type: none"> • Icon is ON if Engine warning is detected. Or one of the engine maintenance schedules has been exceeded.
				Engine decontamination fault (If fitted)	<ul style="list-style-type: none"> • Engine decontamination system fault. In this case, you must contact HAULOTTE Services® as soon as possible.
				DPF regeneration required (If fitted)	<ul style="list-style-type: none"> • Permanently lighted if the particle filter requires regeneration with a high clogging level
				DPF regeneration inhibited (If fitted)	<ul style="list-style-type: none"> • Light stays on if regeneration is inhibited
				Regeneration DPF in progress (If fitted)	<ul style="list-style-type: none"> • Light stays on during regeneration



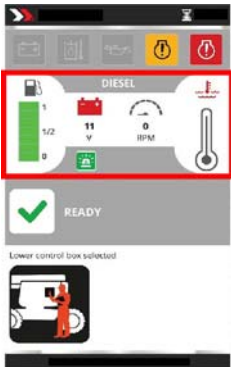
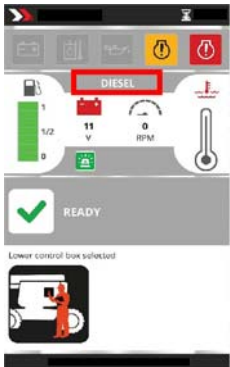
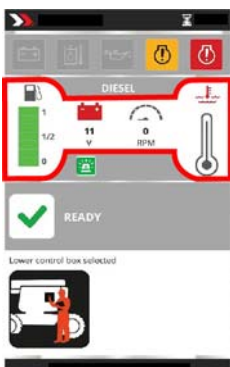



B - Familiarization

Controls and indicators

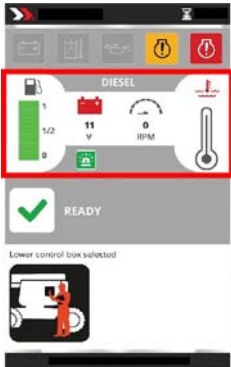
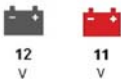
Icon	Description	Function	Icon	Description	Function
Home screen (dashboard) (Will be visible - depending on the machine)					
	Functional information zone			Power mode used	<ul style="list-style-type: none"> • Diesel • GPL / LPG • Electrical
				Bargraph	
				Digital Gauge - Fuel reserve indicator (ON/OFF)	The indicator changes from GREEN to RED when the fuel level is low and indicator is activated
				Analog Gauge - Fuel level gauge	The fuel level indicator switches from GREEN to RED when the fuel level is low

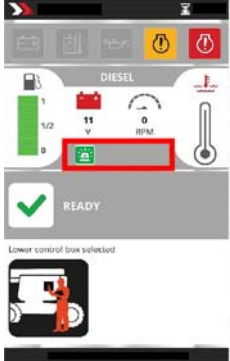
B - Familiarization

Controls and indicators

Icon	Description	Function	Icon	Description	Function
Home screen (dashboard) (Will be visible - depending on the machine)					
	Functional information zone			Charge Battery	Displays the machine battery voltage. The indicator switches to RED if the voltage is low.
				Engine Speed (rpm)	Engine speed display
				Temperature motor	Displays Engine coolant temperature. The indicator switches from GREEN to RED when the engine overheats
				Additional functions	
				Beacon	<ul style="list-style-type: none"> The icon illuminates when the flashing light is switched on
				Working light	<ul style="list-style-type: none"> The icon illuminates when the work light is switched on
				Activ' Lighting System	<ul style="list-style-type: none"> The icon is illuminated when the Activ' Lighting System is switched on in auto or manual mode
				Stop Emission System	<ul style="list-style-type: none"> The icon illuminates if the system is active on the machine

B - Familiarization

Controls and indicators

Icon	Description	Function	Icon	Description	Function
------	-------------	----------	------	-------------	----------

Home screen (dashboard)
(Will be visible - depending on the machine)

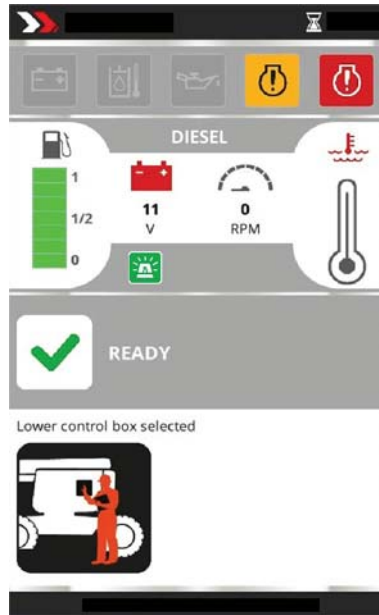

Machine status zone



Pictogram and title

• Displays the pictogram and machine status



Ready

Machine ready, displayed when no failures and no other machine state icons is active







Alarm

Alarm icon is flashing slowly If there is either an active or detected machine failure, or if the machine is in an overload or tilt is active. When the Alarm symbol is displayed, there will also be a symbol displayed to show either the type of machine state, or machine failure that corresponds.





B - Familiarization

Controls and indicators

Icon	Description	Function	Icon	Description	Function
Home screen (dashboard) (Will be visible - depending on the machine)					
				Layout	
				Platform control selected	Selector switch is in platform control box position
				Ground control selected	Selector switch is in ground control box position
				Tilt	The machine is elevated, and is on a slope greater than the permitted slope. Depending on the machine configuration, machine raise and extend functions may be slowed or prevented.
				Overload	The platform is overloaded. Remove the excessive load to or below the rated capacity, to restore functions. In case of an emergency, to rescue the operator in platform, use the Overriding system.

B - Familiarization

Controls and indicators

Icon	Description	Function	Icon	Description	Function
Home screen (dashboard) (Will be visible - depending on the machine)					
				Layout	
				Pre-heating	Engine's automatic preheat system is active. The time to pre-heat will vary according to engine and ambient temperature. Wait before starting the machine
				Radius limitation	Illuminates if the range limit is active or faulty
				Machine is charging	The machine is charging by the engine

A

B

C

D

E

F





G

H

I

B - Familiarization

Controls and indicators

Icon	Description	Function	Icon	Description	Function
Home screen (dashboard) (Will be visible - depending on the machine)					
				Low fuel level	The fuel level is on reserve level. Refill the fuel tank to the marked level. Attention: Lack of fuel may damage the motor/engine and will not be covered under warranty.
				Stop Emission System	Illuminates when the function cuts the engine
				Activ' Lighting System	The function is off. To switch it on, go to the 'Settings' menu
				DPF regeneration required	<ul style="list-style-type: none"> • Permanently lighted if the particle filter requires regeneration with a high clogging level

B - Familiarization

Controls and indicators

Icon	Description	Function	Icon	Description	Function
------	-------------	----------	------	-------------	----------

Home screen (dashboard)
(Will be visible - depending on the machine)

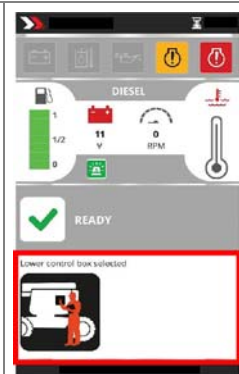
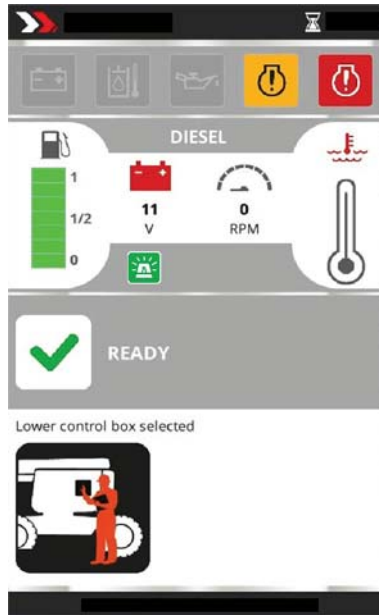

Layout



Diagnostic in progress

The HaulotteDiag console is connected to the machine









Screen software obsolete

Screen software update essential
Contact HAULOTTE Services®

B - Familiarization

Controls and indicators

Icon	Description	Function	Icon	Description	Function
Home screen (dashboard) (Will be visible - depending on the machine)					
				F12.01 bus CAN fault	CAN network fault between the screen and the rest of the machine
				Activ' Shield Bar disable	The secondary safety system is switched off
				Activ' Shield Bar triggered	<p style="text-align: center;"></p> <p>The secondary safety system is triggered. An operator may be trapped on the platform :</p> <ul style="list-style-type: none"> • In this situation, supervisor(s) at ground level must turn the control box key selector (22) to the ground control box  position to take control. • The platform box controls are now de-energized. • Check that the E-Stop button (9) at ground is not pressed in. • To safely activate movements from the ground control box, the enable control (6)  must be pressed and held.

B - Familiarization

Controls and indicators

Icon	Description	Function	Icon	Description	Function
------	-------------	----------	------	-------------	----------

Home screen (dashboard)
(Will be visible - depending on the machine)

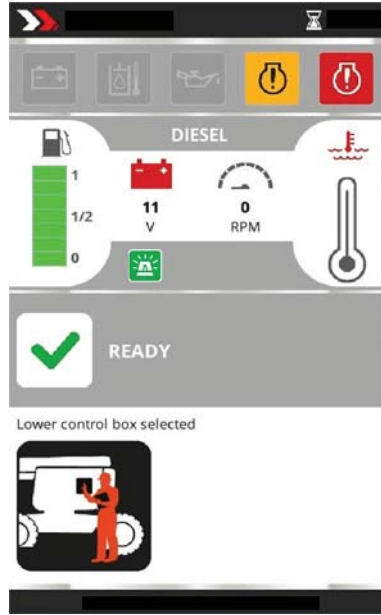

 <p>General information zone</p>	 <p>Machine software version and code</p>	<ul style="list-style-type: none"> Displays the reference and version of the software installed on the machine
	 <p>Machine date and time</p>	<ul style="list-style-type: none"> Displays the date and time of the machine ECU

B - Familiarization

Controls and indicators

Icon	Description	Function	Icon	Description	Function
------	-------------	----------	------	-------------	----------

Machine fault
(Will be visible - depending on the machine)

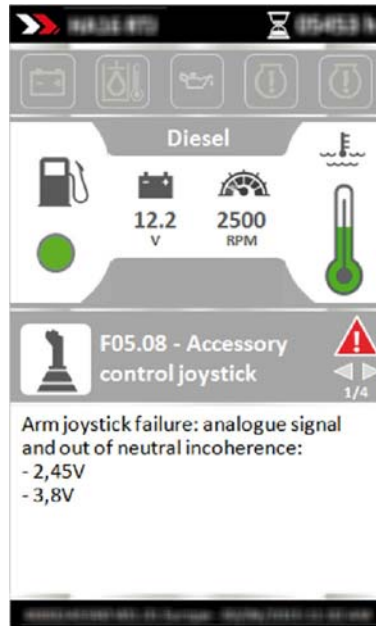

Machine fault icons

	Failure code F01.xx	Fault - Variator		Failure code F09.xx	Fault - IC Engine
	Failure code F02.xx	Fault - power contactor		Failure code F10.xx	Fault - Functions
	Failure code F03.xx	Fault - command relay		Failure code F11.xx	Fault - machine safety
	Failure code F04.xx	Fault - electro-valve		Failure code F12.xx	Fault - electronic control unit ECU

B - Familiarization







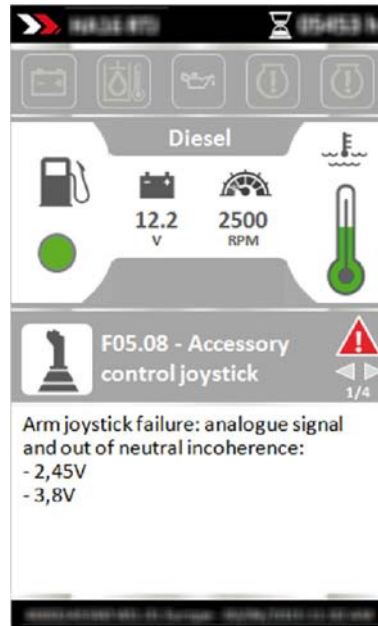

Controls and indicators

Icon	Description	Function	Icon	Description	Function
------	-------------	----------	------	-------------	----------

Machine fault
(Will be visible - depending on the machine)



Machine fault icons

	Failure code F05.xx	Fault - joystick		Failure code F13.xx	Fault - Switches
	Failure code F06.xx	Fault - weight management system		Failure code F14.xx	Fault - Driving pump
	Failure code F07.xx	Fault - limit switch or sensor		Failure code F15.xx	Fault - data communication system CAN
	Failure code F08.xx	Fault - electrical circuit		Failure code F16.xx	Fault - Electric motor

B - Familiarization

3.3 - PLATFORM CONTROL BOX

3.3.1 - Layout

General view



Affichage pupitre de commandes haut (Led 101 - 117)
Platform control box display (Led's 101 - 117)



Controls and indicators

Marking	Name	Description	Function
33	SM902	Drive joystick	Move forward : Forward drive Move backwards : Reverse drive
		Steering rocker switch	Press right side of button : Steer right - According to selected mode (201) Press left side of button : Steer left - According to selected mode (201)
35	SA100	Differential lock selector	Toggle left and hold(Activated) : Maximum drive torque (on difficult or sloping ground) Release (deactivated) : Standard torque
38	SA751	Platform rotation switch	Move to the right : Counter clockwise (CCW) rotation
			Move to the left : Clockwise (CW) rotation
40	SA721	Platform leveling switch	Move upwards : Raise platform
			Move downwards : Platform lowers
41	SA800	Auxiliary power switch	Toggle and hold : Back-up unit activated
			Release : Back-up unit deactivated
43	SA907	Horn button	Push the horn selector to the right to sound the horn
			The horn stops when the selector switch is released

B - Familiarization

Marking	Name	Description	Function
44	SA304	Fuel selector ¹	Push switch to the right for LPG (liquid propane gas supply)
			Push switch to the left for gasoline (petrol) or diesel fuel supply
45	SA110	Drive speed selector	 High-speed drive
			 Medium speed drive
			 Low-speed drive
46	SB802	E-stop button	Pulled out : Platform control box energized
			Pressed in : De-energizes control system (Engine stopped)
49	SM900	Turntable rotation joystick	Move to the right : Counter clockwise (CCW) rotation
		Boom lift joystick	Move to the left : Clockwise (CW) rotation
50	SM901	Arm lift joystick	Move forward : Raise boom
			Move backwards : Lower boom
54	SA531	Boom telescoping switch	Move forward : Arm raises
			Move backwards : Arm lowers
79	SA906	Generator selector ²	Move upwards : Boom retracts
			Move downwards : Boom extends
129	SA621	Jib lifting/lowering switch ³	Move to the left : Generator deactivated
			Move to the right : Generator activated
201	SA101	Steering mode selector ⁴	Hold upwards : Lifting
			Move downwards and hold : Lowering
			2 wheel steering
230	SA303	Engine start-up / stop selector	4 wheel steering - Synchronized axle - Only for PRO model
			Crab steering - Only for PRO model
230	SA303	Engine start-up / stop selector	Move backwards : Starts or Stops the engine (depending on the engine's operating (ON/OFF) mode

1. For machines fitted with
 2. For machines fitted with
 3. For machines fitted with
 4. For machines fitted with

A

B

C

D

E

F

G

H

I

B - Familiarization



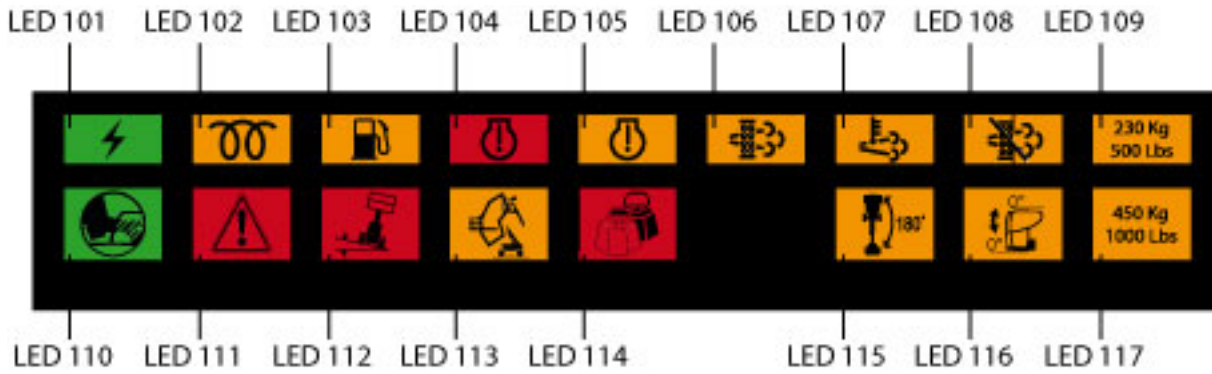

3.3.2 - Display Panel (LED'S 101 - 117)

Platform control box display







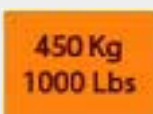







Marking	Name	Symbol	Function
LED 101	HL900		Power ON
LED 102	HL300		Combustion engine pre-heating
LED 103	HL307		Low fuel level
LED 104	HL305		Engine warning
LED 105	HL304		Engine shutdown
LED 106	HL301		regeneration required(Not used)
LED 107	HL302		Regeneration in progress(Not used)
LED 108	HL303		DPF disable
LED 109 ¹	HL805		Not used
LED 110	HL807		Foot pedal switch
LED 111	HL801		Fault
LED 112	HL800		Tilt

B - Familiarization

Marking	Name	Symbol	Function
LED 113	HL804		Not used
LED 114	HL802		Overload
LED 115	HL250		Turret at 180°(Not used)
LED 116	HL720		Platform leveling
LED 117 ²	HL806		Not used





1. If machine equipped with dual load
2. If machine equipped with dual load

B - Familiarization

Symbol	Description
	Machine switched on : <ul style="list-style-type: none"> • Rapid flashing : Machine is ON, but platform control panel is not active but the ground control panel is ON. Also flashes with either E-stop pressed in • Illuminated : Machine is turned on and platform control panel is active.
	Foot pedal switch : <ul style="list-style-type: none"> • Illuminated when foot pedal activated
	Faults : <ul style="list-style-type: none"> • Rapid flashing : If a fault is active (current fault)
	Overload (If machine equipped with weighing system) : <ul style="list-style-type: none"> • Rapid flashing : Faulty weighing / overload system • Illuminated when overloaded
	Tilt sensor (if fitted) : <ul style="list-style-type: none"> • Permanently on in case of tilting, machine folded or unfolded
	Platform levelling +/- 10° : <ul style="list-style-type: none"> • Illuminated if the angle of the platform reaches +/- 10° in relation to the horizontal and movement control
	Low fuel level
	Combustion engine pre-heating : <ul style="list-style-type: none"> • Illuminated while engine is pre-heating • Off if engine started and if post-heating
	Engine warning : <ul style="list-style-type: none"> • Lighted in case of minor engine fault (e.g. water in the diesel, clogged air filter, etc.) • Lighted or flashing in case of fault managed by the engine ECU
	Engine shutdown : <ul style="list-style-type: none"> • Lighted in case of major engine fault (e.g. engine overheating, oil pressure, alternator fault, etc.) • Lighted in case of faults managed by the engine ECU
	DPF regeneration required : <ul style="list-style-type: none"> • Permanently lighted if the particle filter requires regeneration with a high clogging level¹
	DPF regeneration in progress, high temperature in the exhaust system (HEST) : ²
	DPF regeneration inhibited³

1. If engine equipped with Particulate Filter Regeneration
2. If engine equipped with Particulate Filter Regeneration
3. If engine equipped with Particulate Filter Regeneration

B - Familiarization

Filter status	Level of clogging					
DPF cannot be recovered	> 250%	ON				ON
Manual regeneration required (high level)	250% - 180%	ON				OFF
Automatic or manual regeneration required (medium level -> regeneration deactivation must not be engaged)	180% - 130%	ON			OFF	OFF
Automatic regeneration possible (low level)	130% - 90%	OFF			OFF	OFF
Passive regeneration	< 90%	OFF			OFF	OFF
regeneration inhibited			ON			
Active regeneration (automatic or forced)				ON		

A

B

C

D

E

F

G

H

I

B - Familiarization

4 - Performance Specifications

4.1 - TECHNICAL CHARACTERISTICS

Use the table to select the right Haulotte machine for the job.

CE, AS and EAC standards

Machine	HA16RTJ		HA16RTJ O	
	SI	Imp.	SI	Imp.
Characteristics - Dimensions				
Maximum working height	16 m	52 ft 6 in	16 m	52 ft 6 in
Maximum platform height	14 m	45 ft 11 in	14 m	45 ft 11 in
Maximum horizontal reach	8,30 m	27 ft 3 in	8,30 m	27 ft 3 in
Maximum outreach above the ground	7,80 m	25 ft 7 in	7,80 m	25 ft 7 in
Maximum platform height before driving speed restriction	5,20 m	17 ft 5 in	5,20 m	17 ft 5 in
Maximum boom articulation point height	7,60 m	24 ft 11 in	7,60 m	24 ft 11 in
Platform rotation	165° (+ 75° / - 90°)			
Jib working range	140° (+60°/ -80°)			
Boom rotation angle	75°			
Turntable rotation	355°			
Total weight	6200 kg	13,668 lbs	6450 kg	14,222 lbs
Maximum platform capacity	230 kg	500 lb	230 kg	500 lb
Maximum number of occupants allowed	2			
Maximum wind speed allowed	60 km/h	37 mph	60 km/h	37 mph
Manual force - CE - AS	400 N - 90 lbf			
Gradeability - Forwards drive	40%			
Gradeability - Reverse drive	45%			
Sideslope	25%			
Maximum rated slope allowed - CE - AS	5°			
Maximum load on wheel	3090 daN	6,812 lbs	3265 daN	7,340 lbs
Maximum ground pressure of wheel on paved ground	11,44 daN/cm ²	2,38 lb/ft ²	13,2 daN/cm ²	2,70 lb/ft ²
Drive speed :				
• Low	• 0,7 km/h	• 0.4 mph	• 0,5 km/h	• 0.3 mph
• Medium	• 1,3 km/h	• 0.8 mph	• 1,3 km/h	• 0.8 mph
• High	• 2,6 km/h	• 1.6 mph	• 2,6 km/h	• 1.6 mph
• Elevated	• 5,2 km/h	• 3.2 mph	• 5,2 km/h	• 3.2 mph
Maximum freewheel speed during towed operation	5,2 km/h	3.2 mph	5,2 km/h	3.2 mph
Engine - Tier III				
Engine type	Kubota V1505 E2B - 26,5 kW - 35.54 hp			
Engine power	26,5 kW - 35.54 hp			
CO emission	1,14 g/kWh			
HC + NO emission	5,065 g/kWh			
Particles emission	0,311 g/kWh			
Av fuel consumption ¹	3 l/h - 0.79 gal/h			
Fuel type	Diesel			
Engine - Tier IV				
Engine type	Kubota V1505 E4B - 18,5 kW - 24.8 hp			
Engine power	18,5 kW - 24.8 hp			
CO emission	1,4 g/kWh			
HC + NO emission	5,8 g/kWh			
Particles emission	0,21 g/kWh			
Av fuel consumption ²	2,4 l/h - 0.63 gal/h			

B - Familiarization

Machine	HA16RTJ		HA16RTJ O	
Fuel type	Diesel			
Specifications - Performance				
Operating temperature	- 15° C / + 35° C (- 59° F / + 95° F)			
Storage temperature	- 30° C / + 45° C (-22° F / + 113° F)			
Energy storage				
Type of battery	12 V 100 Ah 830A			
Battery amperage	830 A			
Battery voltage	12 V			
Battery capacity	100 Ah			
Hydraulic tank capacity	76 L	21 gal US	76 L	21 gal US
Fuel tank capacity	62 L	16 gal US	62 L	16 gal US

1. Estimated consumption
2. Estimated consumption

A

B

C

D

E

F

G

H

I

B - Familiarization

CE, AS and EAC standards

Machine	HA16RTJ PRO	
Characteristics - Dimensions	SI	Imp.
Maximum working height	16 m	52 ft 6 in
Maximum platform height	14 m	45 ft 11 in
Maximum horizontal reach	8,30 m	27 ft 3 in
Maximum outreach above the ground	7,80 m	25 ft 7 in
Maximum platform height before driving speed restriction	5,20 m	17 ft 5 in
Maximum boom articulation point height	7,60 m	24 ft 11 in
Platform rotation	165° (+ 75° / - 90°)	
Jib working range	140° (+60° / -80°)	
Boom rotation angle	75°	
Turntable rotation	360° Continuous	
Total weight	6650 kg	14,663 lbs
Maximum platform capacity	230 kg	500 lb
Maximum number of occupants allowed	2	
Maximum wind speed allowed	60 km/h	37 mph
Manual force - CE - AS	400 N - 90 lbf	
Gradeability - Forwards drive	40%	
Gradeability - Reverse drive	45%	
Sideslope	25%	
Maximum rated slope allowed - CE - AS	5°	
Maximum load on wheel	3265 daN	7,340 lbs
Maximum ground pressure of wheel on paved ground	13,2 daN/cm ²	2,70 lb/ft ²
Drive speed :		
• Low	• 0,5 km/h	• 0.3 mph
• Medium	• 1,3 km/h	• 0.8 mph
• High	• 2,6 km/h	• 1.6 mph
• Elevated	• 5,2 km/h	• 3.2 mph
Maximum freewheel speed during towed operation	5,2 km/h	3.2 mph
Engine - Tier III		
Engine type	Kubota V1505 E2B - 26,5 kW - 35.54 hp	
Engine power	26,5 kW - 35.54 hp	
CO emission	1,14 g/kWh	
HC + NO emission	5,065 g/kWh	
Particles emission	0,311 g/kWh	
Av fuel consumption ¹	3 l/h - 0.79 gal/h	
Fuel type	Diesel	
Engine - Tier IV		
Engine type	Kubota V1505 E4B - 18,5 kW - 24.8 hp	
Engine power	18,5 kW - 24.8 hp	
CO emission	1,4 g/kWh	
HC + NO emission	5,8 g/kWh	
Particles emission	0,21 g/kWh	
Av fuel consumption ²	2,4 l/h - 0.63 gal/h	
Fuel type	Diesel	
Specifications - Performance		
Operating temperature	- 15° C / + 35° C (- 59° F / + 95° F)	
Storage temperature	- 30° C / + 45° C (-22° F / + 113° F)	
Energy storage		
Type of battery	12 V 100 Ah 830A	
Battery amperage	830 A	
Battery voltage	12 V	

B - Familiarization

Machine	HA16RTJ PRO	
Battery capacity	100 Ah	
Hydraulic tank capacity	76 L	21 gal US
Fuel tank capacity	62L	16 gal US

1. Estimated consumption
2. Estimated consumption

A

B

C

D

E

F

G

H

I

B - Familiarization

ANSI and CSA standards

Machine	HA46RTJ O		HA46RTJ PRO	
Characteristics - Dimensions	SI	Imp.	SI	Imp.
Maximum working height	16 m	52 ft 6 in	16 m	52 ft 6 in
Maximum platform height	14 m	45 ft 11 in	14 m	45 ft 11 in
Maximum horizontal reach	8,30 m	27 ft 3 in	8,30 m	27 ft 3 in
Maximum outreach above the ground	7,80 m	25 ft 7 in	7,80 m	25 ft 7 in
Maximum platform height before driving speed restriction	5,20 m	17 ft 5 in	5,20 m	17 ft 5 in
Maximum boom articulation point height	7,60 m	24 ft 11 in	7,60 m	24 ft 11 in
Turntable rotation	355 °		360° Continuous	
Jib working range	140° (+60°/ -80°)			
Basket rotation angle	Right 90° Left 90°			
Boom rotation angle	75°			
Total weight	6600 kg	14,553 lbs	6650 kg	14,663 lbs
Maximum platform capacity	230 kg	500 lb	230 kg	500 lb
Maximum number of occupants allowed	2			
Maximum wind speed allowed	60 km/h	37 mph	60 km/h	37 mph
Manual force - ANSI - CSA	667 N - 150 lbf			
Gradeability - Forwards drive	40%			
Gradeability - Reverse drive	45%			
Sideslope	25%			
Maximum rated slope allowed - ANSI - CSA	0°			
Maximum load on wheel	3300 daN	7,418 lbs	3265 daN	7,340 lbs
Maximum ground pressure of wheel on paved ground	13,17 daN/cm ²	2,75 lb/ft ²	13,17 daN/cm ²	2,75 lb/ft ²
Drive speed (4WS) :				
• Low	• 0,5 km/h	• 0.3 mph	• 0,5 km/h	• 0.3 mph
• Medium	• 1,3 km/h	• 0.8 mph	• 1,3 km/h	• 0.8 mph
• High	• 2,6 km/h	• 1.6 mph	• 2,6 km/h	• 1.6 mph
• Elevated	• 5,2 km/h	• 3.2 mph	• 5,2 km/h	• 3.2 mph
Maximum freewheel speed during towed operation	5,2 km/h	3.2 mph	5,2 km/h	3.2 mph
Engine - Tier III				
Engine type	Kubota V1505 E2B - 26,5 kW - 35.54 hp			
Engine power	26,5 kW - 35.54 hp			
CO emission	1,14 g/kWh			
HC + NO emission	5,065 g/kWh			
Particles emission	0,311 g/kWh			
Av fuel consumption ¹	3 l/h - 0.79 gal/h			
Fuel type	Diesel			
Engine - Tier IV				
Engine type	Kubota V1505 E4B - 18,5 kW - 24.8 hp			
Engine power	18,5 kW - 24.8 hp			
CO emission	1,4 g/kWh			
HC + NO emission	5,8 g/kWh			
Particles emission	0,21 g/kWh			
Av fuel consumption ²	3 l/h - 0.8 gal/h			
Fuel type	Diesel			
Engine - Dual Fuel (Petrol / Propane Gas)				
Engine type	Kubota WG 1605 - GL - E03- 38 kW - 51 hp			
CO emission	5,3 g/kWh			
HC + NO emission	0,3 g/kWh			
Av fuel consumption ³	Petrol : 3,6 l/h - 0.95 gal/h Gas : 4,3 l/h - 1.13 gal/h			

B - Familiarization

Machine	HA46RTJ O		HA46RTJ PRO	
Fuel type	Petrol/Propane Gas (liquified)			
Specifications - Performance				
Operating temperature	- 15° C / + 35° C (- 59° F / + 95° F)			
Storage temperature	- 30° C / + 45° C (-22° F / + 113° F)			
Energy storage				
Type of battery	12 V 100 Ah 830A			
Battery amperage	830 A			
Battery voltage	12 V			
Battery capacity	100 Ah			
Hydraulic tank capacity	76 L	21 gal US	76 L	21 gal US
Fuel tank capacity	62 L	16 gal US	62 L	16 gal US
Propane bottles	30lb DOT LP gas cylinder			

1. Estimated consumption
2. Estimated consumption
3. Estimated consumption

A

B

C

D

E

F

G

H

I

B - Familiarization

4.2 - WORKING AREA / RANGE OF MOTION

HA16RTJ - HA16RTJ O - HA16RTJ PRO - HA46RTJ O - HA46RTJ PRO

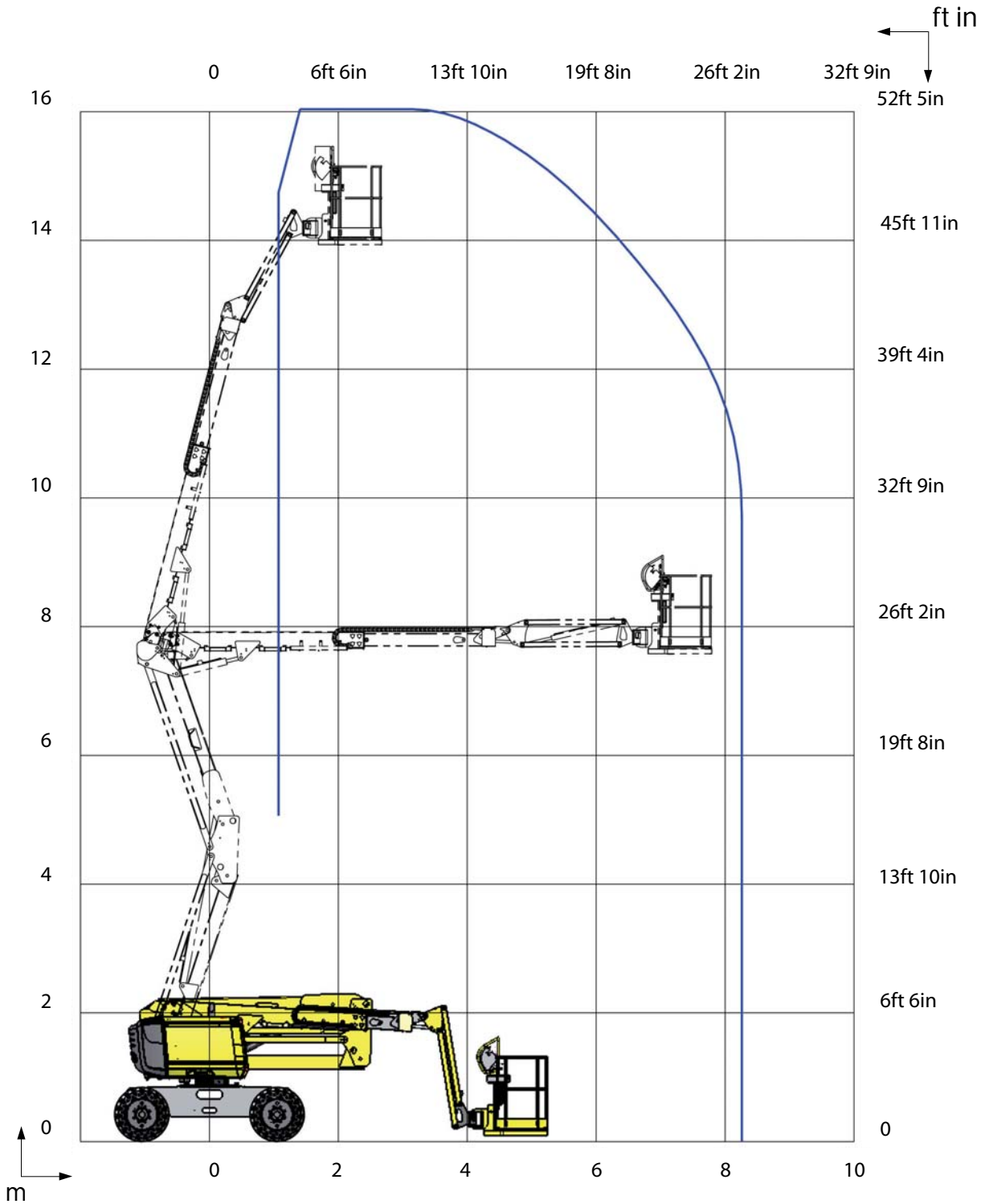

B - Familiarization

5 - Decals and markings locations

CE and AS standards

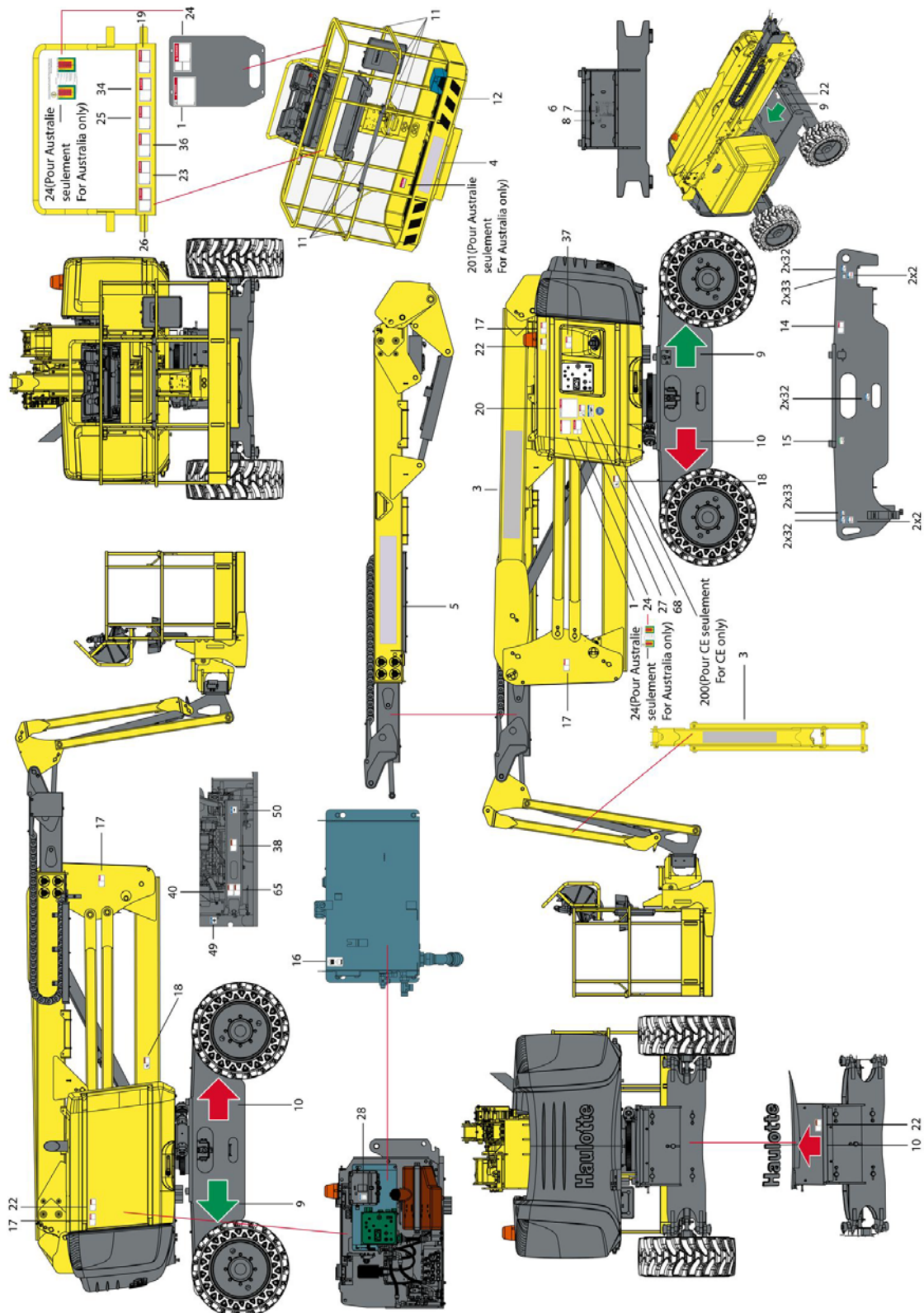

B - Familiarization

CE and AS standards

Marking	Color	Description	Quantity	HA16RTJ	HA16RTJO	HA16RTJ PRO
1	Red	Height of the floor and load	2		4000138310	
2	Blue	Maximum Pressure per Tire - Floor Loading- 850 x 340 wheel	4	4000201400	4000243440	
2	Blue	Maximum Pressure per Tire - Floor Loading- 1025 x 365 wheel	4		4000506600	
3	Other	Commercial name-Bright machine-Horizontal	1	4000138100	4000101940	For CE only : 4000138120 For AS only : 4000101120
3	Other	Commercial name-Dark machine-Horizontal	1	4000138220	4000138200	4000138240
3	Other	Commercial name-Bright machine-Vertical	1	4000138090	4000138130	4000138110
3	Other	Commercial name-Dark machine-Vertical	1	4000138210	4000138190	4000138230
4	Other	Small format HAULOTTE® logo-Bright machine	1		307P217080	
4	Other	Small format HAULOTTE® logo-Dark machine	1		307P220350	
4	Other	Small format HAULOTTE® logo-Red machine	1		307P220360	
5	Other	Large format HAULOTTE® logo-Bright machine	1		307P217230	
5	Other	Large format HAULOTTE® logo-Dark machine	1		307P224930	
5	Other	Large format HAULOTTE® logo-Red machine	1		307P224920	
6	Other	Identification plates	1		307P218070	
8	Other	Noise emission level	1	For CE only : 3078148700		
9	Other	Control of movements - GREEN directional arrow	3		3078143930	
10	Other	Control of movements - RED directional arrow	3		3078143940	
11	Other	Lanyard attachment points - Harness attachment compulsory	9		307P216290	
12	Other	Material risk - Yellow and black adhesive tape	1		2421808660	
14	Red	Risk of crushing - Spindle	1		4000027080	
15	Other	Crown greasing	1		4000025160	
16	Other	Max and min oil level	1		307P221060	
17	Red	Risk of crushing - Do not park	4		4000024800	
18	Orange	Hand crushing hazard - Risk of crushed hands	2		4000024890	
19	Other	Read the operation manual	1		4000025140	



B - Familiarization

20	Red	Operation instructions	1	In german (CE standard) : 307P222730 In english (CE and AS standards) : 307P222740 In croatian (CE standard) : 4000360810 In danish (CE standard) : 307P222760 In spanish (CE standard) : 307P222770 In estonian (CE standard) : 4000360870 In finish (CE standard) : 307P222780 In french (CE standard) : 3078149030 In dutch (CE standard) : 307P222790 In hungarian (CE standard) : 4000360890 In italian (CE standard) : 307P222800 In japanese (CE standard) : 4000359830 In latvian (CE standard) : 4000359840 In lithuanian (CE standard) : 4000359850 In norwegian (CE standard) : 4000359900 In polish (CE standard) : 4000359860 In portuguese (CE standard) : 307P222810 In romanian (CE standard) : 4000359870 In slovakian (CE standard) : 4000359880 In slovenian (CE standard) : 4000359890 In swedish (CE standard) : 307P222820 In greek (CE standard) : 4000561810
22	Orange	Risk of crushing - Do not place foot	4	4000027090
23	Red	Risk of crushing - Driving direction	1	4000024690
24	Red	Danger of electrocution	2	For CE only : 4000025070 For AS only : 4000227500
25	Red	Risk of crushing - Closing drop rail	1	4000025080
26	Red	Danger of electrocution - Ground for welding	1	4000027100
27	Other	Tilt verification	1	4000027110
28	Other	Do not interchange	1	4000504670
32	Blue	Towing anchorage point	6	4000027310
33	Blue	Lifting anchorage point	4	4000027330
34	Red	Electrocution Hazard - Water projection	1	4000025130
36	Red	Risk of crushing - Emergency lowering	1	4000027460
37	Red	Risks of explosion	1	4000027370
38	Orange	Hand crushing hazard - Heat burns	1	4000027450
40	Orange	Hand crushing hazard-Snapping up	1	4000027430
49	Blue	Battery +	1	4000071960
50	Blue	Battery -	1	4000071970
65	Orange	Wear protective equipment	1	4000027440
68	Other	Transport height	1	4000417540
200	Other	Made in Europe	1	For CE only : 4000137690
201	Red	Wearing of a safety harness is essential	1	AS standard only : 4000275670

B - Familiarization

ANSI and CSA standards

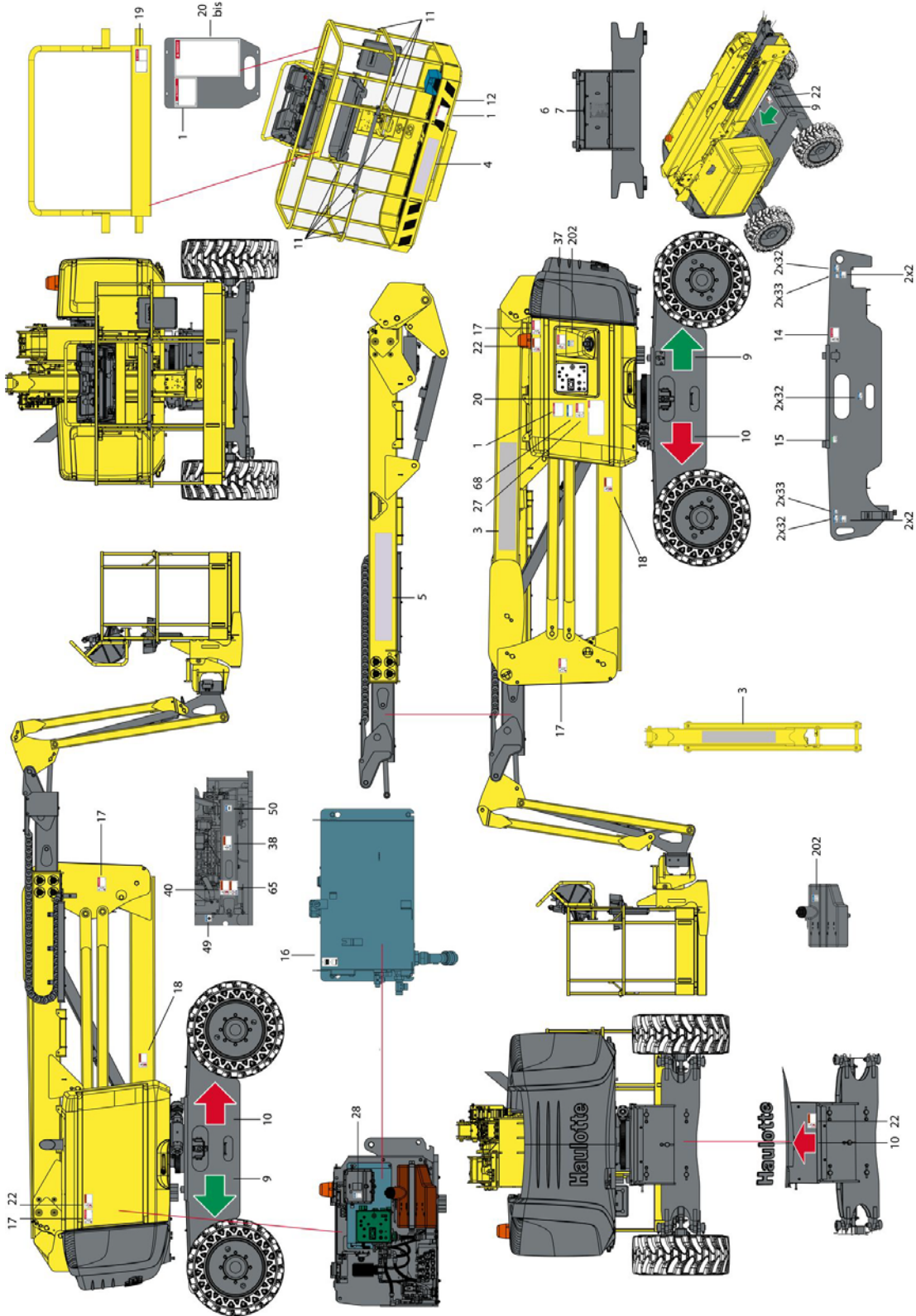

B - Familiarization

ANSI and CSA standards

Marking	Color	Description	Quantity	HA46RTJ	HA46RTJO	HA46RTJ PRO
1	Red	Height of the floor and load	3	In english : 4000101090 In french : 4000101100 In spanish : 4000101110		
2	Blue	Maximum Pressure per Tire - Floor Loading- 850 x 340 wheel	4	4000201400	4000243450	
2	Blue	Maximum Pressure per Tire - Floor Loading- 1025 x 365 wheel	4		4000506600	
3	Other	Commercial name-Bright machine-Horizontal	1	4000138160	4000138140	4000138180
3	Other	Commercial name-Dark machine-Horizontal	1	4000138280	4000138260	4000138300
3	Other	Commercial name-Bright machine-Vertical	1	4000138150	4000138130	4000138170
3	Other	Commercial name-Dark machine-Vertical	1	4000138270	4000138250	4000138290
4	Other	Small format HAULOTTE® logo-Bright machine	1	307P217080		
4	Other	Small format HAULOTTE® logo-Dark machine	1	307P220350		
4	Other	Small format HAULOTTE® logo-Red machine	1	307P220360		
5	Other	Large format HAULOTTE® logo-Bright machine	1	307P217230		
5	Other	Large format HAULOTTE® logo-Dark machine	1	307P224740		
5	Other	Large format HAULOTTE® logo-Red machine	1	307P220360		
6	Other	Identification plates	1	307P218070		
9	Other	Control of movements - GREEN directional arrow	3	3078143930		
10	Other	Control of movements - RED directional arrow	3	3078143940		
11	Other	Lanyard attachment points - Harness attachment compulsory	9	307P216290		
12	Other	Material risk - Yellow and black adhesive tape	1	2421808660		
14	Red	Risk of crushing - Spindle	1	In english : 4000024830 In french : 4000068080 In spanish : 4000086510		
15	Other	Crown greasing	1	4000025160		
16	Other	Max and min oil level	1	307P221060		
17	Red	Risk of crushing - Do not park	4	In english : 4000024640 In french : 4000067680 In spanish : 4000086460		
18	Orange	Hand crushing hazard - Risk of crushed hands	1	In english : 4000024770 In french : 4000067710 In spanish : 4000086490		
19	Other	Read the operation manual	1	4000025140		
20	Red	Operation instructions	1	In english : 4000027580 In french : 4000083200 In spanish : 4000086650		
20bis	Red	Operation instructions-Vertical	1	In english : 4000027570 In french : 4000068880 In spanish : 4000086640		

B - Familiarization

22	Orange	Risk of crushing - Do not place foot	4	In english : 4000024840 In french : 4000068180 In spanish : 4000086610
27	Other	Tilt verification	1	In english : 4000024860 In french : 4000068090 In spanish : 4000086520
28	Other	Do not interchange	1	4000504670
32	Blue	Towing anchorage point	6	4000027310
33	Blue	Lifting anchorage point	4	4000027330
37	Red	Risks of explosion	1	In english : 4000025010 In french : 4000068130 In spanish : 4000086560
38	Orange	Hand crushing hazard - Heat burns	1	In english : 4000025040 In french : 4000068110 In spanish : 4000086540
40	Orange	Hand crushing hazard-Snapping up	1	In english : 4000025020 In french : 4000068100 In spanish : 4000086530
49	Blue	Battery +	1	4000071960
50	Blue	Battery -	1	4000071970
65	Orange	Wear protective equipment	1	In english : 4000025030 In french : 4000068120 In spanish : 4000086550
68	Other	Transport height	1	4000417540
202	Other	Diesel Fuel Only	2	4000201430

B - Familiarization

EAC standard

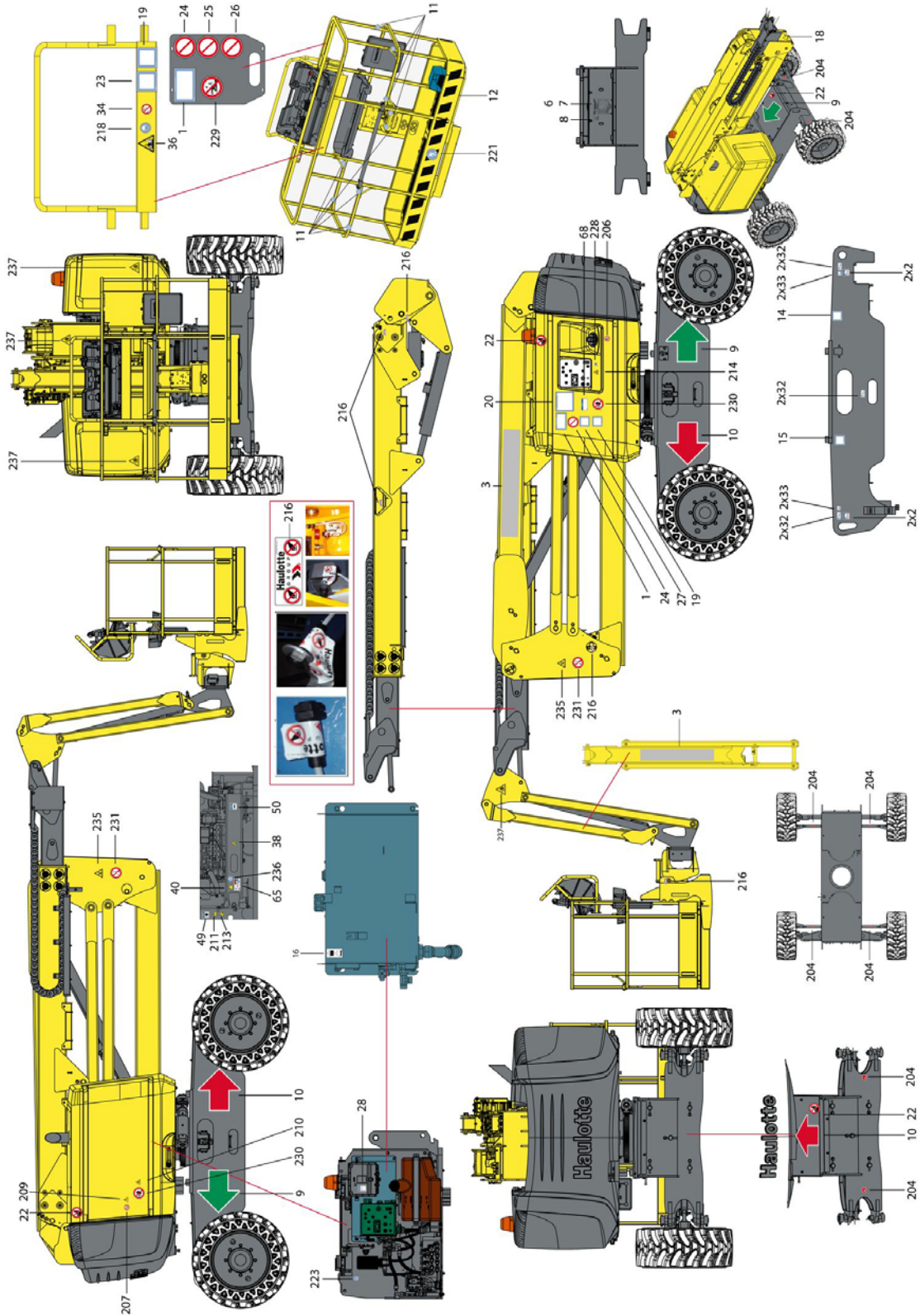

B - Familiarization

EAC standard

Marking	Color	Description	Quantity	HA16RTJ	HA16RTJO	HA16RTJ PRO
1	Red	Height of the floor and load	2	4000270060		
2	Blue	Maximum Pressure per Tire - Floor Loading- 850 x 340 wheel	4	4000201400	4000243440	
2	Blue	Maximum Pressure per Tire - Floor Loading- 1025 x 365 wheel	4	4000506600		
3	Other	Commercial name-Bright machine-Horizontal	1	4000138100	4000101940	4000101120
3	Other	Commercial name-Dark machine-Horizontal	1	4000138220	4000138200	4000138240
3	Other	Commercial name-Bright machine-Vertical	1	4000138090	4000138130	4000138110
3	Other	Commercial name-Dark machine-Vertical	1	4000138210	4000138190	4000138230
6	Other	Identification plates	1	For Russia : 4000278870 For Ukraine : 307P227830		
8	Other	Noise emission level	1	3078148700		
9	Other	Control of movements - GREEN directional arrow	3	3078143930		
10	Other	Control of movements - RED directional arrow	3	3078143940		
11	Other	Lanyard attachment points - Harness attachment compulsory	9	307P226710		
12	Other	Material risk - Yellow and black adhesive tape	1	2421808660		
14	Red	Risk of crushing - Spindle	1	307P227810		
15	Other	Crown greasing	1	307P227060		
16	Other	Max and min oil level	1	307P221060		
18	Orange	Hand crushing hazard - Risk of crushed hands	1	307P227660		
19	Other	Read the operation manual	1	For Russia : 307P227190 For Ukraine : 307P227840		
20	Red	Operation instructions	1	For Russia : 4000359920 For Ukraine : 4000359910		
22	Orange	Risk of crushing - Do not place foot	4	307P227010		
23	Red	Risk of crushing - Driving direction	1	307P227040		
24	Red	Danger of electrocution	2	307P226960		
25	Red	Risk of crushing - Closing drop rail	1	307P226950		
26	Red	Danger of electrocution - Ground for welding	1	307P226970		
27	Other	Tilt verification	1	For Russia : 307P227060 For Ukraine : 307P227870		
28	Other	Do not interchange	1	4000504670		
32	Blue	Towing anchorage point	6	4000135970		
33	Blue	Lifting anchorage point	4	4000135960		
34	Red	Electrocution Hazard - Water projection	1	307P226780		
36	Red	Risk of crushing - Emergency lowering	1	4000014290		
38	Orange	Hand crushing hazard - Heat burns	1	4000200810		
40	Orange	Hand crushing hazard-Snapping up	1	307P226940		
49	Blue	Battery +	1	4000071960		
50	Blue	Battery -	1	4000071970		
65	Orange	Wear protective equipment	1	4000027440		

B - Familiarization

68	Other	Transport height	1	4000417540
204	Other	Lubrication point	9	307P219370
206	Other	Flames prohibited	1	307P226750
207	Other	Smoking forbidden	1	307P226760
209	Other	Battery danger	1	307P226790
210	Other	Fire Hazard	1	307P226800
211	Other	Electrical danger	1	307P226810
213	Other	Corrosion hazard	1	307P226830
214	Other	Danger unstable side H41	1	307P226930
216	Other	Tamper-proof	For Russia : • For HA16RTJ 307P227450 x 8. • For HA16RTJO 307P227451 x 10. • For HA16RTJPRO 307P227452 x 10. For Ukraine : • For HA16RTJ 307P227453 x 8. • For HA16RTJO 307P227454 x 10. • For HA16RTJPRO 307P227455 x 10.	
218	Other	Caution helmet compulsory	1	307P226680
221	Other	Obligatory routing	1	307P227510
223	Other	Plug 12 V	1	307P227700
225	Other	Cold weather oil	1	307P223700
228	Other	Horn	1	4000014830
229	Other	Do not travel down slopes in high speed	1	307P226990
230	Other	No admittance	2	307P227560
231	Other	Do not park in the work area	2	307P227000
235	Other	Risk of crushing	2	4000014270
236	Other	Caution glasses	1	307P226670
237	Yellow	Lateral crushing of the body	4	307P227670

C - Pre-operation inspection

1 - Recommendations

The owner, the site manager, the supervisor and the operator are all responsible to ensure the machine is fit for the work it is to perform; i.e. that the machine is suitable to carry out the work in complete safety and in compliance with this Operator's Manual. All managers who are responsible for persons operating the machine must be familiar with the local regulations currently applicable in the country of use and ensure that they are adhered to.

Before using the machine, read the previous chapters in this manual. Ensure that you have understood the following points :

- Safety precautions.
- Operator's responsibilities.
- Conditions and the operating principles of the machine.

2 - Working area assessment

To ensure safety during operation, the following should be considered :

- Segregate other site traffic (delivery vehicles, dumpers, etc) from the work area.
- Check the work area for localized features, e.g. manholes, service ducts, potholes, etc.
- Check ground covers (temporary and permanent) are strong enough to withstand the applied pressure
- Check ground covers are secured and monitor them. Take similar action for permanent covers.
- Check the load bearing capacity (distributed load and point loading, e.g. outriggers) when working inside a building, or on a structure.
- Check the load bearing capacity (distributed load and point loading, e.g. outriggers) of the supporting ground.
- Provide supervision to ensure safe systems of work are appropriate and being used.
- Check for overhead crushing and contact hazards.
- Check weather conditions have not altered ground conditions (e.g. heavy or prolonged rain).
- Establish limits for safe operation (e.g. maximum wind speed). Remember conditions can change internally (e.g. if roller doors are opened).
- Comply with permit to work systems where sites have them (e.g. chemical plants).
- Provide a rescue plan for all risks, including falls and crush hazards. Ensure personnel understand and are appropriately trained in the rescuing procedures. Site based personnel trained in operation of functions and in the emergency lowering systems from the ground control box should be present. Ensure that access to the ground controls is available.

C - Pre-operation inspection

- Assess other alternative work methods or equipment before operating near a steep slope. If the machine must be placed near an edge or steep slope, ensure barriers are available to support the weight of the machine. Take into consideration the machine's stopping distance. If this is not possible, evaluate and establish the placement of machine and sequence of operations so that the aerial work platform can operate in a safe manner (e.g. machine is in line with the edge rather than towards the edge).

Extra care must be taken if aerial work platforms are used to manoeuvre up through several levels of steelwork. There is a risk of the operator being trapped should the basket strike the steelwork.

This risk increases with the number of steelwork levels and if material is piled up on lower level reducing the spacing between levels.

C - Pre-operation inspection

3 - Inspection and Functional test

3.1 - DAILY INSPECTION

Each day before the beginning of a new work session and with each change of operator, the machine must be subjected to a visual inspection and a complete functional test.



- Never use a defective or a malfunctioning aerial work platform.
- If any item on the check list is marked "No" during the inspection; machine must be tagged and placed out of service.
- Do not operate the machine until all identified items are corrected and it has been declared safe for operation.

In case of loose fasteners, refer to torque table value in maintenance book.

In case of leaks, replace the damaged part before use.

In case of structural part deformation, cracks, broken weld, paint chips, replace the part before use.

Sample of broken welds

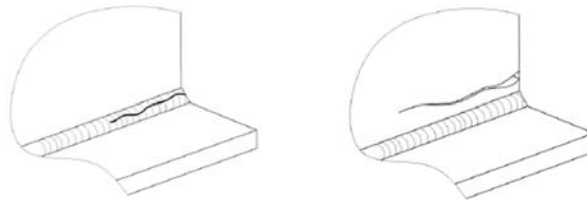

Inspection Forms are provided to assist your inspection process.

We recommend these forms to be completed daily and stored to assist with your maintenance schedule.

Each action is depicted in the daily inspection sheet using the following symbols.

	Visual inspection without disassembly		Lubrication-Grease		Functional adjustments
	Drain		Test and validate		Tighten
	Check levels		Systematic replacement		
	Visual inspection with small disassembly or movement needed to reach the part. Replacement is necessary.		Proof tests : Need HAULOTTE Services® authorization. For countries where machines are not subject to controlled periodic maintenance.		

C - Pre-operation inspection

		Daily inspection			
	Visual inspection without disassembly		Check level		
			To check by test		
		Yes	No	Corrected	Not applicable
Manuals and displays. Clean or replace if necessary.					
	Presence, cleanliness and legibility of the manufacturer's plate				
	Presence, cleanliness and legibility of operator's and maintenance manuals				
	Presence and cleanliness of load chart of the machine				
Control box (Ground and Platform)					
	Presence and cleanliness of the control box				
	No visible damage				
	All decals at the control boxes are clean and legible				
	Operation of start / stop device				
	Operation of E-stop button device				
	Operation of enable switch				
	Operation of horn from platform control box				
	Operation of movement from platform control box				
	Test warning alarm lights and buzzer				
	Overriding indicators turn off after 1 sec				
	No abnormal noise and jerky movements from platform control box				
	Joysticks and movement switches return to neutral				
Work Platform. Floor, guardrails, access and extensions					
	Absence of cracks, broken parts, damaged paint				
	No deterioration and visible damage				
	Harness anchor points are not cracked or damaged, with the decal attached and legible				
	No screws missing / loose parts				
	Entry bar/gate closes automatically and is not prevented from closing.				
	Folding guard-rail (if fitted) is fixed securely in position				
Lift assembly (jib, boom, mast, arm, turret)					
	Absence of cracks, broken parts, damaged paint				
	No deterioration and visible damage				
	No screws missing / loose parts				
	No foreign body in joints or slides				
	Presence of securely fitted maintenance devices (safety stand)				
	All compartments covers open and lock properly				
Frame, axle, steering system, stabilizers arms ...					

C - Pre-operation inspection

Absence of cracks, broken parts, damaged paint					
No deterioration and visible damage					
No screws missing / loose parts					
No foreign body in joints or slides					
Condition of tires/tyres (wear, cutting, damage ...)					
Wheel reducer is undamaged and operates smoothly					
All compartments covers open and lock properly					
Rotation system : orientation turret, basket and jib					
Absence of cracks, broken parts, damaged paint					
No deterioration and visible damage					
No screws missing / loose parts					
No foreign body in joints or slides					
Exterior gear wheel greasing					
Pin, pin stop, bearing ...					
Presence of the turret pin and its locking device					
No bent, cracked or broken pins, pin stops, bushes or bearings					
Pulleys, chains and wire rope					
No cracked or broken chains, links and fittings					
Pulleys and clamps are not worn, rusted or damaged					
Cylinder and hydraulic component : pumps, filters, manifold					
No leaks on the pump, tank or fittings					
No deformation, visible damage, broken weld or leaks on hydraulic cylinder					
No screws missing / loose parts					
Presence and operation of hydraulic filter (no clogged)					
Check hydraulic oil level is above the minimum level (Machine folded)					
Energy storage and motorisation: tanks, batteries and engine					
Engine oil level (add in stowed position)					
Fuel level (add in stowed position)					
No screws missing / loose parts					
Presence and good condition of hydraulic hose					
Presence and good condition of engine components					
Presence and good condition of the batteries: terminations and clamps, electrolyte level ...					
Electric cables					
No torn or split wire sheaths					
No evidence of chemical damage or corrosion on all cables					
No oxidation or corrosion on terminals					
Sensors and safety device					

A

B

C

D

E

F

G

H

I

C - Pre-operation inspection

Activation of Activ'Shield Bar					
Stabilizers operate correctly and lock securely in position					
Slope limiting device operates properly					
Axle locking device operate properly					
Pothole safety device operate properly (if equipped)					
Test of load sensing system (visual warning at control box)					
Serial number :	Model : Signature :				
Hours of operation :					
HAULOTTE Services® contract reference :					
Intervention record number :					
Date :					
Name :					

C - Pre-operation inspection

4 - Safety functional checks

To protect the user and the machine, safety systems prevent the movement of the machine beyond its operating limits. These safety systems when activated immobilize the machine and prevent further movement.

The operator must be familiar with this technology and understand that is not a malfunction but an indication that the machine has reached an operation limit.

Aerial Work platforms are equipped with two control boxes which allow operators to safely use the machine. An auxiliary device (overriding system) is available on ground control box when primary power source fails. Each control box is equipped with an E-Stop button, which cuts all movements when pushed in.

The following checks describe the operation of the machine and the specific controls required.

For the location and description of these controls :  refer to section B 3.2 and D 2 Ground control box and B 3.3 and D 3 Platform control box.

4.1 - E-STOP BUTTON CHECK

Ground control box E-stop button

Step	Action
1	Pull both E-Stop buttons (9) at ground box and (46) at platform box.
2	Set the key switch (22) at ground box to the  position
3	The indicator (10) lights up on ground display panel
4	Start the engine by pressing the engine start-up selector (16) .
5	Push the E-stop button (9) .
6	Check that the engine stops running.
7	Check no movements are functional.

Platform control box E-stop button

Step	Action
1	Pull out the E-Stop button (9) at ground box.
2	Set the key switch (22) at ground box to the  position
3	The indicator (13) lights up on ground display panel
4	Pull out the E-Stop button (46) at platform box.
5	Start the engine from platform using Start/Stop switch (230) .
6	Push in E-Stop button (46) at platform.
7	Check that the engine stops running.
8	Check no movements are functional.

C - Pre-operation inspection

4.2 - ACTIVATION OF CONTROLS

The enable switch must be active to allow all movements.

The "Enable Switch" system depends on the machine configuration and will consist of one of the following :

- Joystick trigger at platform box (if fitted).
- Foot pedal switch in the basket.
- Enable switch button at ground box.

4.3 - FAULT DETECTOR

The machine is equipped with an on-board fault detection system, which indicates the type of fault to the operator.

The fault is identified by a default code.

The default code is displayed at the ground control box.

According to the type of fault, the machine MAY switch into DOWNONLY mode and certain movements are prevented to maintain Operator's safety.

Do not use the machine until the fault has been corrected.

4.3.1 - Indicators/LED's test

From the ground control box

Step	Action
1	Pull both the E-Stop buttons (46) at platform box and (9) at ground box.
2	Set the key switch (22) at ground box to the  position
3	Check that the indicators (10, 13, 15, 19) and ACTIV'SCREEN (23) are lit.
4	Check that the LED's on the display are all turned off after 1 sec.

From the platform control box

Step	Action
1	Pull E-Stop button (9) at ground box.
2	Set the key switch (22) at ground box to the  position
3	Check that the indicators (10, 13, 15, 19) and ACTIV'SCREEN (23) are lit.
4	First push in the E-Stop button (46) at platform box, then pull out.
5	Check that the LED's (101 - 117) light up on the platform display panel.
6	Check that the LED's (101 - 117) on the display are all turned off after 1 sec.

C - Pre-operation inspection

4.3.2 - Buzzers test

From the ground control box

Step	Action
1	Pull both E-Stop buttons (9) at ground box and (46) at platform box.
2	Set the key switch (22) at ground box to the  position
3	Buzzers at ground and platform will beep.

4.4 - AUTOMATIC ENGINE CUT-OUT

The engine automatically cuts out in the following conditions :

- The alternator is not functioning.
- Engine temperature is too high.
- Oil pressure is too low.
- E-Stop(s) are pushed in.
- The machine is switched off.

4.5 - OVERLOAD SENSING SYSTEM (IF FITTED)

If the platform load exceeds the maximum allowed load, no movement is possible from the 2 control boxes.

At ground and platform control boxes a buzzer sounds and an indicator light warns the operator

To return the machine to normal operation remove weight from the platform until the load is below the maximum allowed load.

Daily check that the LED's illuminate when the machine is switched on :

- Verify that the Overload system is active : Refer to Indicator (15) at ground and LED (114) at platform.
- Verify that the buzzers are functioning : Refer to Buzzers test

A periodic inspection of this device must be performed according to the recommendation in Maintenance Schedule.

C - Pre-operation inspection

4.6 - OSCILLATING AXLES (IF EQUIPPED)

To improve the driving capability on rough terrain, the front axle is equipped with an oscillating mechanism. When the extending structure is retracted and is in the stowed position, oscillating mechanism is unlocked to adapt itself to the features of ground operation. When the extending structure is out of the stowed position, a safety device locks the oscillating mechanism to reduce overturning hazard.

A visual inspection must be performed periodically to ensure the absence of leaks from the oscillating cylinder and associated plumbing connections including the hydraulic hoses.

A periodic inspection of this device must be conducted according to the recommendation in the maintenance schedule.

4.7 - SLOPE WARNING DEVICE

From each control box, a buzzer alerts the operator that the machine is not folded/stowed and is positioned on a slope exceeding the slope allowed.

N.B.-:THE SLOPE SENSOR IS ONLY ACTIVE WHEN THE PLATFORM IS NOT IN THE STOWED POSITION.

When machine is on a slope greater than the rated slope, with extending structure out of the stowed position, DRIVE function is disabled(For CE, AS and CSA only).

All the lifting movements are cut. Only the lowering movements are authorized.

In this case, fully lower the platform and reposition the machine on level ground before raising the platform again.

To restore DRIVE function, perform the following steps before repositioning on level ground :

Machine on slope with the platform uphill





Step	Action
1	Retract the boom.
2	Lower the bottom arm.
3	Lower the upper boom

Machine on slope with the platform downhill

Step	Action
1	Lower the upper boom.
2	Lower the top arm.
3	Retract the boom.

C - Pre-operation inspection

To check the tilt sensor at ground level

Step	Action
1	Open the right hand compartment cover (Component location diagrams) and locate the tilt sensor (C28).
2	Pull both E-Stop buttons; (9) at ground box and (46) at platform box.
3	Set the key switch (22) at ground box to the  position
4	Start the engine by pressing the engine start-up selector (16) START / STOP.
5	To stow the machine : <ul style="list-style-type: none"> • Retract the boom using the command (3) by pressing and holding the button  • Lower the boom using the boom raising (4) by pressing and holding the button  • Lower the arm using the arm raising (5) by pressing and holding the button 
6	Raise the boom to more than 10 degrees above horizontal using the control boom raising (4) by pressing and holding the button 
7	Raise the boom to more than 10 degrees above horizontal using the raise/lower switch (10).
8	While manually tilting the sensor (C28), move it towards the front and hold.
9	Check that the audible beep sounds.

C - Pre-operation inspection

4.8 - TRAVEL SPEED LIMITATION

The machine has a selector of 3 driving speeds - low, medium and high.

All driving speeds are authorised when extending structure of the machine is in stowed position (transport configuration). Drive speed is proportional to the movement of the drive joystick (33). Adjust position of Jib to enhance field of vision during driving.

When the machine is elevated, drive speed is automatically reduced, regardless of the drive speed chosen.

Daily check that the speed is limited to less than 1 km/h (0.6 mph) when :

- The boom is raised by more than 10° above horizontal.
- The boom is telescoped/extended more than 400 mm (16 in.).
- The arm is raised by more than 2 m (6 ft 7 in) above horizontal.

D - Operation instructions

1 - Operation



1.1 - INTRODUCTION

Only trained and authorized personnel shall be permitted to operate this aerial work platform.

Prior to operation :

- Read, understand and obey all instructions and safety precautions in this manual and attached to the aerial work platform.
- Read, understand and obey all Federal, State and local codes and regulations.
- Become familiar with the proper use of all controls and emergency systems.

1.2 - OPERATION FROM THE GROUND CONTROL BOX

- Turning "ON" and "OFF" of the machine is performed with the Control box activation key selector (22).
- Activation of a desired control box is achieved by turning the Control box activation key selector (22) to the desired position  .
- The ground control box is energized and is active ONLY when :
 - The E-stop buttons on both ground and platform control boxes are not pressed in (Deactivated).
 - To switch ON the machine, turn the Control box activation key selector (22) at the ground control box on ground control box position .
- An E-Stop button at each control box stops all movements when pressed in; including shutting off an engine (if equipped).

N.B.-:-DO NOT TURN OFF THE POWER SUPPLY OF THE MACHINE USING THE E-STOP BUTTON(USE ONLY IN CASE OF EMERGENCY). TURN OFF THE POWER SUPPLY OF THE MACHINE USING THE



CONTROL BOX ACTIVATION KEY SELECTOR 22 TO  POSITION.

- An "Enable switch" (6) is present that should be activated and maintained to authorize one or more movements. If enable switch (6) is kept engaged without selecting a function movement for more than 8 seconds ; enable switch is automatically de-activated
- The release of control box enable switch while performing a movement stops all the movements. The function movement is progressively slowed down. If the enable switch is re-pressed, the function movement does not restart. The function movement can only be selected when the corresponding function switch or joystick is returned to neutral position.
- All controls and joystick operating a movement, return automatically to neutral when released.
- At power up, all switches and joysticks must be in their neutral position.

D - Operation instructions

- 'Enable Switch' selector / Back-up unit selector (6) :
 - With engine running, the control switch functions as an "enable control" only.
 - With engine stopped, the control function as the "enable control" and allows the back-up unit (emergency pump) functioning.
- Overriding system : The ground control box is designed for maintenance and emergency rescue operations only. Refer to  Section D 4.2 To rescue operator in platform. .
- The status of the controls is tested automatically when the machine is switched on. A control will be active only after it has been detected to be in neutral position. The flashing light control (14) is not controlled :
- A control (16) provides the start and stop of the engine.
- A buzzer beeps in the following conditions :
 - When power is switched on.
 - Overload (if fitted).
 - When machine is on a slope greater than the rated slope.
 - Hydraulic oil overheating.
 - Movements option.
- Indicators : Indicators (10), (13), (15) and (19) are checked when the machine is powered on

US destined machines :

- For desired type of fuel; activate button (18)  for petrol or (17)  for propane gas

D - Operation instructions

1.3 - OPERATION FROM THE PLATFORM CONTROL BOX

- The platform control box is energized only when :
 - The E-stop buttons on both ground and platform control boxes are not pressed in.
 - To switch ON the machine, turn the Control box activation key selector (22) at the ground control box on ground control box position .
 - Platform control box is energized by turning the control box energizing selector switch (229) at the ground control box to the left.
 - Overriding system not activated.
- A faulty joystick is not taken into account to control a movement. If this fault disappears, the movement is authorised again.
- An E-Stop button at each control box stops all movements when pressed in; including shutting off an engine (if equipped).

N.B.-:DO NOT TURN OFF THE POWER SUPPLY OF THE MACHINE USING THE E-STOP BUTTON(USE ONLY IN CASE OF EMERGENCY). TURN OFF THE POWER SUPPLY OF THE MACHINE USING THE

CONTROL BOX ACTIVATION KEY SELECTOR (22) TO  POSITION.

- A foot pedal switch (C42) is present that should be activated and maintained to authorize one or more movements. If foot pedal switch is kept engaged without selecting a function movement for more than 8 s; foot pedal switch is automatically de-activated.
- The release of foot pedal switch while performing a movement, stops that function movement and all other movements are inactive. The stop of movements is progressive. If the "Enable switch" is pressed again quickly within 0,5 s the movement restarts. If the "Enable switch" is not pressed again quickly enough within + 0,5 s the movement will not restart. It could restart only when the selected function switch/joystick is released to neutral position.
- All switches and joystick operating a movement, return automatically to neutral when released.
- At power up, all switches and joysticks must be in their neutral position.

For the US destined machines :

- The fuel selection (petrol or liquid propane gas) is done by turning the switch (44) to the desired position.
- The status of the switches is tested automatically when the machine is switched on and checked at every starting. A switch will be activated only after it has been detected in neutral position.

D - Operation instructions

- A buzzer beeps in the following conditions :
 - When power is switched on.
 - When platform is overloaded (if fitted).
 - When machine is on a slope greater than the rated slope.
- Emergency pump. ( Section D 4.1 In case of engine power failure)
- Indicators - All indicators (LEDs 101 - 117) are checked when the machine is powered on

1.4 - OPERATION OF OVERRIDING SYSTEM FROM GROUND CONTROL BOX



Please refer to paragraph  D.4.2 To rescue operator in platform.

D - Operation instructions

2 - Ground control box

2.1 - TO START AND STOP THE MACHINE - DIESEL ENGINE

- Check that the E-stop buttons (9) at ground control box and (46) at platform control box are not pressed in.
- Turn the control box selector (22) on position  to energize the ground control box. The LED display panel comes on.
- Push the starter selector (16) upwards. The engine starts. The indicator goes out.
- Let the engine heat up.

To shut-down the machine from the ground control box :

- Push the starter selector (16) upwards. The engine stops.
- Turn the key activation selector switch (22) in position .
- The machine is now switched off.

N.B.-:-THIS OPERATION TURNS THE MACHINE OFF AND IT IS REQUIRED TO PREVENT BATTERY DISCHARGE.

2.2 - TO START AND STOP THE MACHINE - PETROL / GAS (PROPANE) ENGINE

- Open the gas bottle valve (C140)
- At the ground control box, check that the E-stop button (9) is not pressed in.
- Turn the control box selector (22) on position  to energize the ground control box.
- Press the propane gas control (17) for liquid gasoline supply.
- Press the starter selector (16) to start the engine.
- Let the engine heat up.

To shut-down the machine from the ground control box :

- Press the starter selector (16) to stop the engine.
- Turn the activation selector key switch (22) to off position .
- Power supply is now switched off.

N.B.-:-THIS OPERATION TURNS OFF THE POWER SUPPLY TO MACHINE AND IT IS REQUIRED TO PREVENT BATTERY DISCHARGE.

- Close the gas bottle valve (C140).



If the gas bottle is empty, the engine stops. Press switch (18) for gasoline supply. Restart the engine.









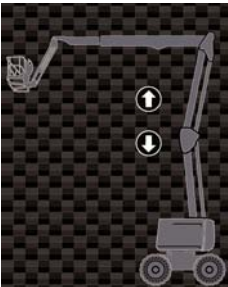

D - Operation instructions

2.3 - BOOM AND ARM CONTROLS

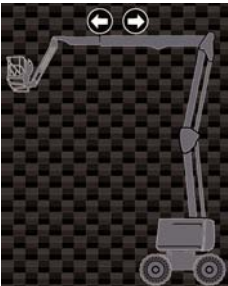



Platform leveling is available, regardless of the work height. Even at low movement speeds, use the controls with caution.

N.B.-:-RELEASING THE ENABLE SWITCH (FOOTPEDAL) WILL STOP ALL MOVEMENTS.

Ground box controls (emergency station)

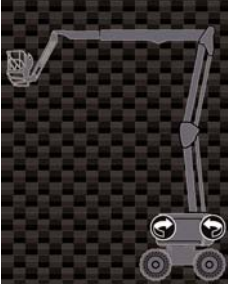
Control	Action
Raising / lowering of boom 	Press the boom raising control (4) to raise  the boom.
	Press the boom lowering control (4) to lower  the boom.
Raising / lowering of arm 	Press the arm raising control (5) upwards  to raise the arm
	Press the arm lowering control (5) downwards  to lower the arm
Boom telescope extend/retract 	Press the boom telescoping control (3) to extend  the boom.
	Press the boom retracting control (3) to retract  the boom.
Jib raising / lowering (If applicable) 	Press the jib raising control (2) to raise  the jib.
	Press the jib lowering control (2) to lower  the jib.

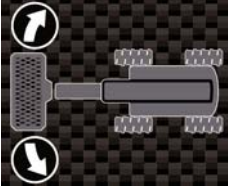
D - Operation instructions

Control	Action
Turntable rotation 	Press the turntable rotation control (7) for a clockwise rotation  Press the turntable rotation control (7) for an anti-clockwise rotation 
Platform rotation 	Press the platform rotation control (8) for a clockwise rotation  Press the platform rotation control (8) for an anti-clockwise rotation 

2.4 - ADDITIONAL CONTROLS

- Press the beacon light control (14)  to turn ON or OFF be beacon light.

D - Operation instructions

3 - Platform control box

3.1 - TO START AND STOP THE MACHINE

To start the machine :

At the ground control box :

- Check that the E-stop button (9) is not pressed in.
- Turn the control box key selector (22) on position  to energize the machine and activate the platform control box

At the platform control box :

- Check that the E-stop button (46) is not pressed in.
- Push the starter selector switch (230) upwards. During pre-heating, the indicator (102) comes ON on the display panel of the platform control box. Pre-heating begins and the engine starts.
- Allow the engine to heat up and initialize.

To stop the engine :

- Push engine start switch (230) upwards.

3.2 - TO START AND STOP THE MACHINE - PETROL / GAS (PROPANE) ENGINE

To start the machine :

At the ground control box :

- Open the gas bottle valve.
- Check that the E-stop button (9) is not pressed in.
- Turn the control box key selector  on position (22) to energize the machine and activate the platform control box

At the platform control box :

- Open the gas bottle valve.
- Check that the E-stop button (46) is not pressed in.
- Turn the petrol/liquid propane gas selector (44) into LPG position
- Push the starter selector switch (230) upwards. During pre-heating LED (102) at platform display panel and LED (5) at ground display panel will light up. Pre-heating begins and the engine starts.
- Allow the engine to heat up and initialize.

To stop the engine :

- Push engine start switch (230) upwards.
- Close the gas bottle valve



If the gas bottle is empty, the engine stops. Turn the petrol/liquid propane gas selector (44) into G position. Restart the engine.





D - Operation instructions

3.3 - DRIVE AND STEER CONTROL

To activate drive and steer function, press the foot pedal switch and simultaneously operate the joystick (33) for the desired function.

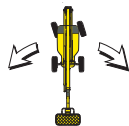
Before driving, locate the green / red orientation arrows on the chassis and platform controls. Move the drive control joystick (33) in the direction matching the directional arrows.

N.B.-: -ON UNEVEN TERRAIN, LOWER THE BOOM TO IMPROVE THE DRIVE PERFORMANCE.

Control	Action
Steering	Press thumb/rocker switch on joystick (33) to the right to steer right.
	 Press thumb/rocker switch on joystick (33) to the left to steer left.
Driving	Move joystick (33) forwards for the machine to travel in the forward direction.
	 Pull joystick (33) backwards for the machine to travel in the reverse direction.
Drive speed	Position the drive speed selector switch (45) on  for high-speed driving.
	Position the driving speed selector (45) on  for medium speed driving (crossing uneven ground, slope).
	Position the driving speed selector (45) on  for low-speed driving (short distance, final approach, unloading from lorries/trucks).



D - Operation instructions

3.4 - BOOM AND ARM CONTROLS

Activate the desired control and the 'Enable switch' foot pedal simultaneously to perform that selected function.

'Enable Switch' foot pedal

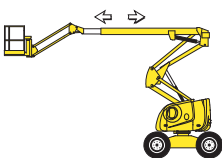
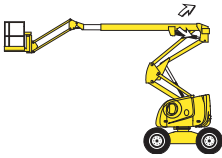
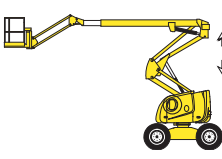

Control	Action
<p>Boom telescope extend/retract</p> 	<p>Push the boom telescoping switch (54) upwards to retract the boom.</p> <hr/> <p>Push the boom telescoping switch (54) downwards to extend the boom.</p>
<p>Boom raising / lowering</p> 	<p>Move the boom/turntable joystick (49) forward to raise the boom.</p> <hr/> <p>Move the boom/turntable joystick (49) backwards to lower the boom.</p>
<p>Arm raising / lowering</p> 	<p>Push the arm joystick (50) forwards to raise the arm.</p> <hr/> <p>Push the arm joystick (50) backwards to lower the arm.</p>
<p>Jib raising / lowering</p> 	<p>Push the jib switch (129) upwards to raise the jib.</p> <hr/> <p>Push the jib switch (129) downwards to lower the jib.</p>

D - Operation instructions

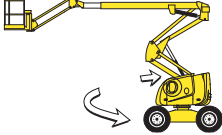
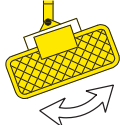
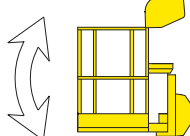
Control	Action
Turntable rotation 	Move the boom/turntable joystick (49) to the left for a clockwise (CW) rotation. Move the boom/turntable joystick (49) to the right for a counter clockwise (CCW) rotation.
Platform rotation 	Move the platform rotation switch (38) to the right for a counter clockwise (CCW) rotation. Move the platform rotation switch (38) to the left for a clockwise (CW) rotation.
Platform leveling 	Move the platform leveling switch (40) upwards to raise the platform. Move the platform leveling switch (40) downwards to lower the platform.

3.5 - ADDITIONAL CONTROLS

- Horn : Push the horn selector (43) to the right to sound the horn. The horn stops when the selector switch is released.

D - Operation instructions

4 - Emergency procedure

4.1 - IN CASE OF POWER LOSS

In case of loss of the main power source, the secondary (back-up) power unit, powered by the starting battery, allows movements to be controlled from both the ground and platform control boxes.

As the electric pump has limited power, it is advisable to reach the ground in the most direct manner possible.

The use of the electric pump is exclusively reserved for lowering the boom in emergency situations only. It is recommended to first retract the boom before lowering the boom. Performing other operations can lead to the deterioration of the electric pump.

N.B.-:TEST THE OPERATION OF EMERGENCY SYSTEM ATLEAST ONCE A MONTH. REFER TO THE MAINTENANCE MANUAL

Depending on the control box in use, push and hold the back-up/auxiliary power switch (6) at ground box or switch (41) at platform box. Retract the boom and lower it by using controls (3), (4) and (4) at ground control box or switch (54) and joystick (49) at platform control box.

In an emergency, if the operator has to exit the platform while it is elevated, the transfer of the operator must respect the following recommendations. :

- Exit onto a sturdy and safe structure.
- The occupant(s) must ensure that 2 lanyards are used for security/safety. One must be attached to the designated anchorage point on platform the occupant(s) is in and the other attached to the structure intended to get on.
- Do not leave platform without taking into account the allowance for possibility of boom deflection when exiting platform.
- Occupant(s) must exit the current platform through the normal access.

N.B.-:DO NOT DETACH THE LANYARD FROM THE CURRENT PLATFORM IF THE TRANSFER TO THE NEW STRUCTURE POSES ANY DANGER OR UNTIL THE TRANSFER IS SAFELY COMPLETED. DO NOT ATTEMPT TO CLIMB DOWN THE BOOM. INSTEAD WAIT FOR ASSISTANCE FOR A SAFE EXIT.

D - Operation instructions

4.2 - TO RESCUE OPERATOR IN PLATFORM

In a situation where an operator located in the platform needs to be rescued (for example in case of illness, injury or trapped against a structure making the control box inaccessible), the rescue personnel at ground level needs to obtain rapid and direct access to operating functions.

HAULOTTE® provides a ground control emergency system that should be used to safely bring the operator into such a position that appropriate medical attention could be provided.



The system allows occupant(s) to be lowered to the ground level, even if an E-Stop is engaged or if an overload is detected.

In this situation, supervisor(s) at ground level must turn the control box key selector (22) to the ground control box  position to take control.

To safely activate movements from the ground control box, the enable control (6)  must be pressed and held



Procedure :

- Turn the ground control box key control (22) to the ground control box  position.
- The platform box controls are now de-energized.
- Check that the E-Stop button (9) at ground is not pressed in.
- To lower the platform, hold down the enable switch (6) and simultaneously activate the desired control function.







N.B.-:IF THE PLATFORM E-STOP BUTTON (46) OR A SAFETY DEVICE DOES NOT ALLOW NORMAL MOVEMENT FROM THE GROUND CONTROL BOX, THE OVERRIDING SYSTEM IS OPERATED AS FOLLOWS.



Operation of the "overriding system" switch must be an exception and not a normal emergency operation.



Procedure :

- Press and hold the "overriding" system control (11) .
- Press simultaneously the telescoping boom control (3) to retract the boom .
- Press the boom raising control (4) to raise  or lower  the boom.
- Press the arm raising control (5) to raise  or lower  the arm.

N.B.-:ONCE RESCUE OPERATIONS ARE COMPLETE, WRITE AN INCIDENT REPORT. OVERRIDING SYSTEM MUST BE RESET BY A HAULOTTE SERVICES® TECHNICIAN.

D - Operation instructions

4.3 - NO POWER AVAILABLE

In case of loss of the main power and the secondary power unit not functioning, do not attempt to activate any function movement using hydraulic manifold unless trained and authorized by HAULOTTE Services®. All safety functions are no longer active and several hazards may occur. Improper use of the equipment will result in death or serious injuries.



If the operator cannot be lowered by any of the above mentioned methods, contact HAULOTTE Services® immediately.

D - Operation instructions

5 - Transportation

5.1 - PUTTING IN TRANSPORT POSITION

During loading, ensure that :

- The loading ramp can support the machine weight.
- The loading ramp is correctly attached to transport vehicle.
- The loading ramp has sufficient grip surface.
- The transport vehicle must be parked on a level surface and must be secured to prevent rolling away while machine is being loaded or unloaded.

To climb the slope, select low driving speed.

If the slope is too steep, use a winch in addition to the low speed drive.

Do not place yourself below or too close to the machine during loading.

A wrong move can lead to machine tipping over and may cause serious injuries and material damage.

The machine must be completely in the stowed configuration :

- Check the platform is completely empty.
- Lower the boom and drive onto the truck bed.
- Ensure that the jib is raised as necessary to give ground clearance when driving the machine onto the loading ramp.
- Secure the machine to the tie down points provided (Section D-Machine layout).
- Lock the turntable with the rotation stop pin located under the turntable before transporting (Section D-Machine layout).
- The platform/basket must be chocked and the boom strapped to prevent bouncing up and down, thus preventing possible material damage during transporting.
- Do not use excessive downward force when securing boom section.

D - Operation instructions

5.2 - MACHINE LAYOUT

Turret rotation enabled

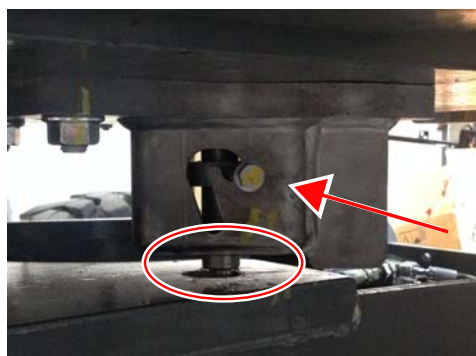

Turret rotation disabled

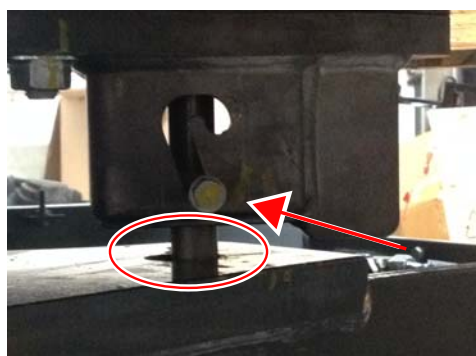

Machine stowing

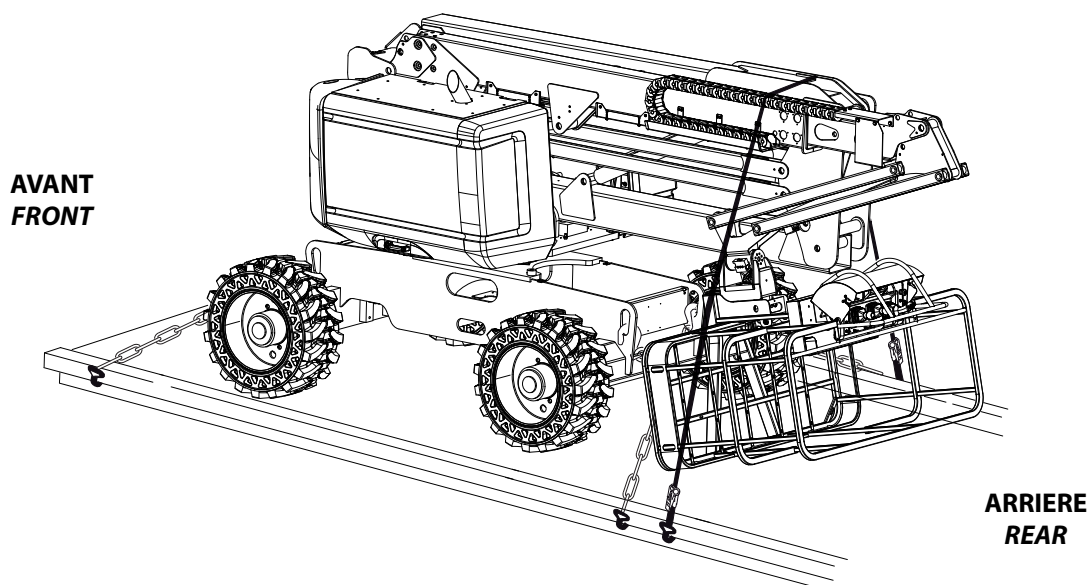

N.B.:-SECURE TURNTABLE WITH THE TURNTABLE LOCKING PIN BEFORE TRAVELING LONG DISTANCES OR HAULING MACHINE ON A TRUCK.

D - Operation instructions

5.3 - UNLOADING

Before unloading, check that the machine is in good condition.

- Remove the turntable rotation locking pin (Section D-Machine layout).
- Remove the tie downs.
- Select low drive speed at the platform control box.
- Start the machine from platform control box.



Warning : Upon starting a machine that has been secured and transported, the safety system may detect a false overload preventing all movement from the platform control box.

To reinstate the system, lift the jib a few centimetres (inches) using the ground control box.

5.4 - TOWING



In the event of a machine breakdown, the machine can be towed a short distance to load it onto a transport vehicle :

- Ensure that no one is in the platform during towing.
- Ensure boom is in the stowed position and the turntable is locked, prior to towing.
- The platform must be empty.

To tow a broken-down machine, disconnect the wheel drive hubs.

Perform this operation on flat ground with wheels chocked.

In the towing configuration, the machine braking system is inactive. Use of a drawbar is recommended :

- Do not exceed the maximum freewheel speed (Refer to  Section B 4 Technical specifications).
- Do not exceed a grade of 25%.

5.4.1 - Disengaging the drive hubs

Unscrew the central nut (1) until the nut is at the limit.



When drive hubs are disengaged, the machine is in free wheel mode and the brake system no longer functions.

D - Operation instructions

5.4.2 - Re-engaging the drive hubs

- To return machine to normal operation and braking, reverse the steps performed in disengaging the drive hubs.



Carry out a few driving movements. The drive hubs are now re-engaged.

5.5 - STORAGE

When the machine is in elevated position, it is necessary to regularly switch the power ON to ensure that the security systems are active.

Machine must be parked in a protected/designated area with the boom in a stowed configuration, however the boom can be raised but must not be extended. Make sure there is no load in the platform.

It is recommended that the machine is not stored or immobilized unfolded.

Ensure all access panels, doors and side compartment covers are shut and secured.

At the ground control box, set the key control box activation (22) to the  to shut OFF the machine.

Ensure that the turntable rotation locking pin is removed and stored properly.

Remove the ignition key to prevent unauthorized operation of the machine.



Storing of the machine with an obstacle under the boom structure is forbidden.

D - Operation instructions

5.6 - LIFTING OPERATION

During loading / unloading operation, if it becomes necessary to lift the machine using an overhead crane, it is important to respect the following :

- Put the machine in stowed position, boom and arm fully retracted and lowered.
- Ensure the platform is empty.
- Rotate the turret and the jib to the configuration in the photos below.
- Lock the turret with turret locking pin.
- Verify that lifting accessories are in good operation and match the technical specifications listed below. It is important that the lifting devices are attached only to the designated lifting eyes.
- Each of the slings used for lifting the machine must be adjusted to keep the machine level and to minimize the risk of damage to the machine.

- Anchorage point for lifting are identified / labeled by the following symbol .
- ONLY trained and authorized personnel should attempt to lift the machine.



Never lift the machine with slings attached to counterweight.

Procedure for the use of slings

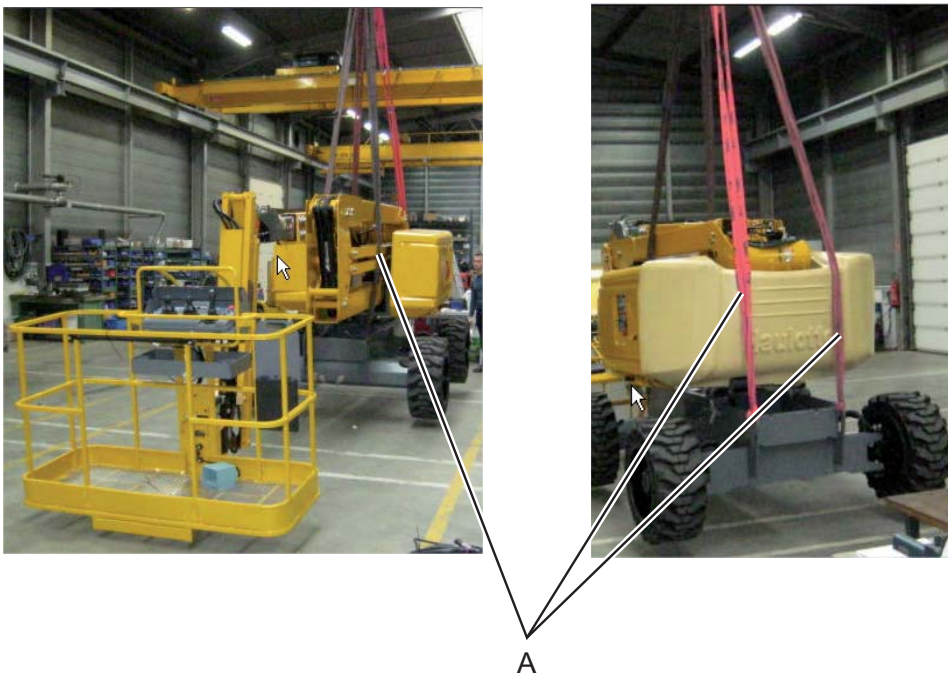

	Number of shackles	Number of slings	Length	Maximum load per sling and shackle
A	4	4	5 m (16 ft 5 in)	3000 daN (6744 lbf)

D - Operation instructions

6 - Cold Weather Recommendations

In cold weather conditions, allow engine to run for at least 5 min to warm up ; before operating any function thereby preventing any damage to the hydraulic system.

In extreme cold conditions, machines should be equipped with optional cold start kits.

Attempting to start engine when temperature is in the negative range, may require the use of a booster battery.

If engine fails to start, do not crank for an extended time. Allow starter to "cool off" for a few minutes before attempting again. If engine fails after several attempts, refer to the engine maintenance manual.

N.B.-:INITIAL STARTING SHOULD ALWAYS BE PERFORMED FROM THE GROUND CONTROL BOX.

6.1 - ENGINE OIL

The correct SAE viscosity grade of oil is determined by the minimum ambient temperature during cold engine start-up, and the maximum ambient temperature during engine operation.

Generally, use the highest viscosity oil that is available to meet the requirement for the temperature at start-up.

EMA LGR-1 / API CH-4 Viscosity grade	Engine oil viscosity	
	Minimum	Maximum
SAE 0W20	-40°C (-40°F)	10°C (50°F)
SAE 0W30	-40°C (-40°F)	30°C (86°F)
SAE 0W40	-40°C (-40°F)	40°C (104°F)
SAE 5W30	-30°C (-22°F)	30°C (86°F)
SAE 5W40	-30°C (-22°F)	40°C (104°F)
SAE 10W30	-20°C (-4°F)	40°C (104°F)
SAE 15W40	-10°C (14°F)	50°C (122°F)

N.B.-:FOR ADDITIONAL ENGINE RECOMMENDATION, REFER TO THE ENGINE MANUAL PROVIDED WITH THE MACHINE.

D - Operation instructions

6.2 - HYDRAULIC OIL

External environmental conditions can reduce performance of the machine if the hydraulic oil temperature does not reach its optimum range.









It is recommended to use the hydraulic oil according to weather condition. Refer to the table below.

Environmental conditions	SAE Viscosity grade
Ambient temperature between - 15°C (5°F) and + 40°C (+ 104°F)	HV 46
Ambient temperature between - 35°C (- 31°F) and + 35°C (+ 95°F)	HV 32
Ambient temperature between 0°C (+ 32°F) and + 45°C (+ 113°F)	HV 68

N.B.:-IT IS RECOMMENDED TO REPLACE LOW TEMPERATURE OIL AS THE AMBIENT TEMPERATURE REACHES + 15°C (59°F). IT IS NOT ADVISABLE TO MIX OILS OF DIFFERENT BRANDS OR TYPES.

D - Operation instructions

6.3 - PREHEATING OPERATION

- Activate a control box by turning Control box activation key control (22)  to the desired position  or .
- The ground control box indicators (10) , (13) , (15) , and (19)  light up. The engine is in pre-heating mode.
- Upon the extinction of the LEDs, the engine is ready to start.
- Press the engine start button (16) , to start the engine.

E - General Specifications

1 - Machine dimensions

Stowed / Transport position : Configuration that takes the minimum floor space necessary for storage and / or delivery of the machine - Access position.

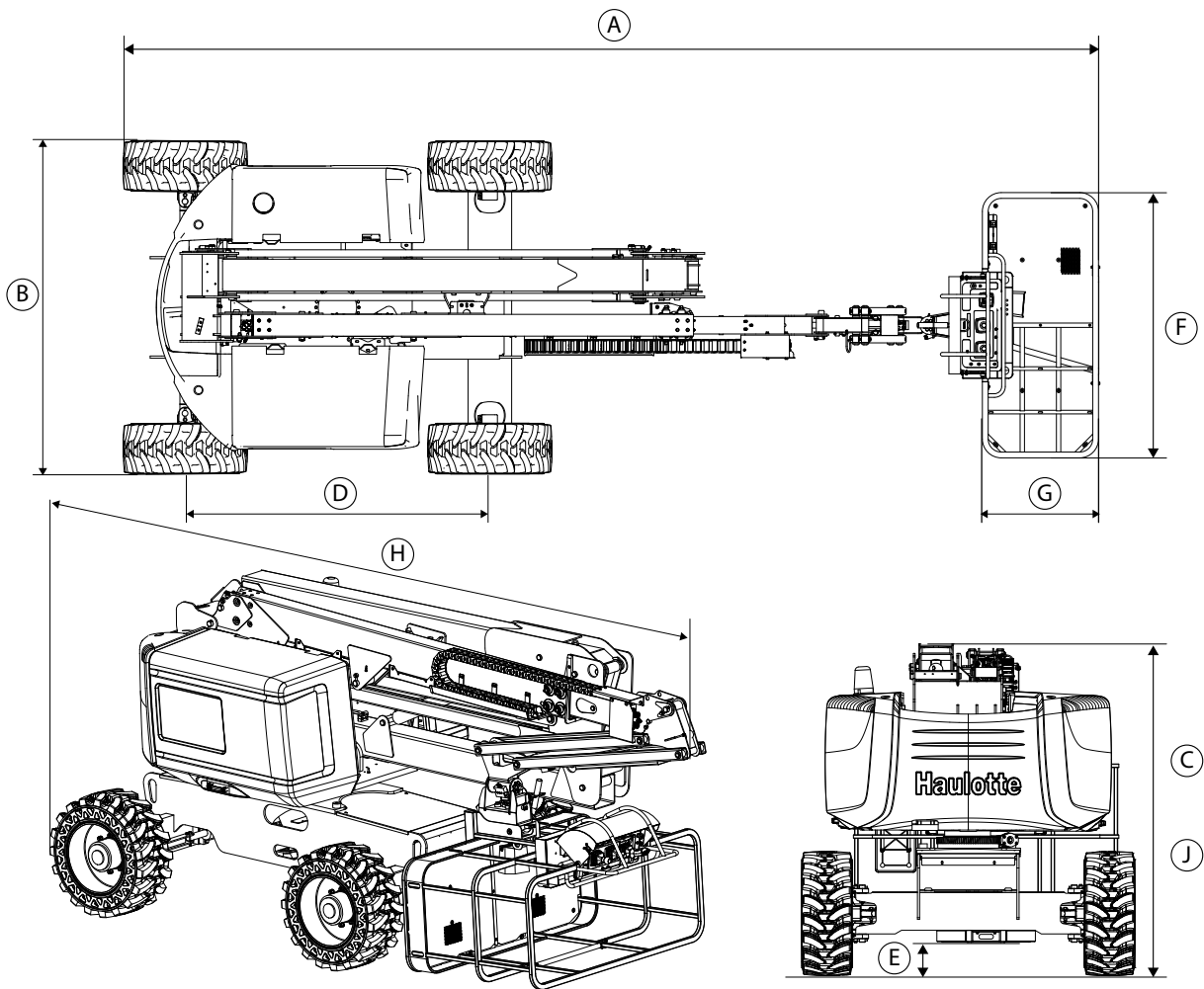

CE and AS standards

Marking	Machine Specifications - Dimensions	HA16RTJ		HA16RTJ O	
		SI	Imp.	SI	Imp.
A	Overall length of machine	6,75 m	22 ft 2 in	6,75 m	22 ft 2 in
B	Overall width of machine	2,30 m	7 ft 7 in	2,30 m	7 ft 7 in
C	Overall height of machine	2,30 m	7 ft 7 in	2,30 m	7 ft 7 in
D	Wheel base	2,10 m	6 ft 11 in	2,10 m	6 ft 11 in
E	Ground clearance	38 cm	15 in	38 cm	15 in
F X G	Platform dimensions	1,8 x 0,8 m	5 ft 11 in x 2 ft 7 in	1,8 x 0,8 m	5 ft 11 in x 2 ft 7 in
H	Storage length	5,05 m	16 ft 7 in	5,05 m	16 ft 7 in
J	Storage height	2,40 m	7 ft 10 in	2,40 m	7 ft 10 in
	Outside turning radius - 2WS	4,5 m	14 ft 9 in	4,5 m	14 ft 9 in
	Inside turning radius - 2WS	2,4 m	7 ft 10 in	2,4 m	7 ft 10 in

E - General Specifications

CE and AS standards

Machine		HA16RTJ PRO	
Marking	Specifications - Dimensions	SI	Imp.
A	Overall length of machine	6,75 m	22 ft 2 in
B	Overall width of machine	2,30 m	7 ft 7 in
C	Overall height of machine	2,30 m	7 ft 7 in
D	Wheel base	2,10 m	6 ft 11 in
E	Ground clearance	38 cm	15 in
F X G	Platform dimensions	1,8 x 0,8 m	5 ft 11 in x 2 ft 7 in
H	Storage length	5,05 m	16 ft 7 in
J	Storage height	2,40 m	7 ft 10 in
	Outside turning radius - 4WS	3,75 m	12 ft 4 in
	Inside turning radius - 4WS	1,75 m	5 ft 9 in

ANSI and CSA standards

Machine		HA46RTJ O		HA46RTJ PRO	
Marking	Specifications - Dimensions	SI	Imp.	SI	Imp.
A	Overall length of machine	6,75 m	22 ft 2 in	6,75 m	22 ft 2 in
B	Overall width of machine	2,30 m	7 ft 7 in	2,30 m	7 ft 7 in
C	Overall height of machine	2,30 m	7 ft 7 in	2,30 m	7 ft 7 in
D	Wheel base	2,10 m	6 ft 11 in	2,10 m	6 ft 11 in
E	Ground clearance	38 cm	15 in	38 cm	15 in
F X G	Platform dimensions	1,8 x 0,8 m	5 ft 11 in x 2 ft 7 in	1,8 x 0,8 m	5 ft 11 in x 2 ft 7 in
H	Storage length	5,05 m	16 ft 7 in	5,05 m	16 ft 7 in
J	Storage height	2,40 m	7 ft 10 in	2,40 m	7 ft 10 in
	Outside turning radius - 2WS	4,5 m	14 ft 9 in	3,75 m	12 ft 4 in
	Inside turning radius - 2WS	2,4 m	7 ft 10 in	1,75 m	5 ft 9 in

E - General Specifications

2 - Major component masses

N.B.-:MASSES MEASURED WITH EMPTY TANKS.

Component	HA16RTJ	HA16RTJ O	HA16RTJ PRO
Frame assembly mass	1950 kg - 4,300 lbs	2150 kg - 4,741 lbs	2 300 kg - 5,072 lbs
• Mass of each wheel	182 kg +/- 4 kg (401 lbs +/- 9 lbs)		
Turret assembly mass	760 kg - 1,676 lbs		
• Counterweight mass - Turret	1365 kg - 3,010 lbs	1465 kg - 3,230 lbs	
• Engine compartment mass	255 kg - 562 lbs		
• Battery mass	21 kg - 46 lbs		
Boom assembly mass	420 kg - 926 lbs		
Arm assembly mass	860 kg - 1,896 lbs		
Jib assembly mass	100 kg - 221 lbs		
Platform assembly mass	200 kg - 441 lbs		

3 - Acoustics and vibrations

The acoustics and vibrations specifications are based upon the following conditions :

- The airborne noise emissions at workstation are determined per European Directive 2006/42/CE.
- The guaranteed sound power level LWA (displayed on the product) is determined per European Directive 2000/14/CE.
- The vibrations transmitted by the machinery to the hand/arm system and to the whole body are determined per European Directive 2006/42/CE.

Specifications	
Sound pressure level at workstation	80 dBA
Guaranteed sound power level	104 dBA
Vibrations hand/arm	Vibration transmitted by this MEWP to the hand-arm does not exceed 2,5 m/s ² (98,4 in/s ²)
Vibrations whole body	Vibration transmitted by this MEWP to the whole body does not exceed 0,5 m/s ² (19,6 in/s ²)

E - General Specifications

4 - Wheel/Tire assembly

4.1 - TECHNICAL SPECIFICATIONS

Component	Standard wheel
Reference number	"solideal 850 x 340"
Type	Solid Tyre (Curred - on)
Wheel mass	182 kg +/- 4 kg (401 lbs +/- 9 lbs)
Size	850 mm +/- 4 mm (34 in/ 1 in)
Torque	320 Nm (236 lbs ft)

4.2 - INSPECTION AND MAINTENANCE



The tire and rim are bonded together, both must be replaced if either is damaged.

Wheels replacement must be made in the following cases :

- Deformation or cracks on the rim.
- De-bonding between the interface of the steel and the rubber.
- Uniform wear to the wearing line :
 - 850 x 340 wheel : \varnothing 782 mm / 34 in
 - 1025 x 365 wheel (Optional) : \varnothing 962 mm / 41 in



- Non-linear wearing of the tread profile (> 10%)

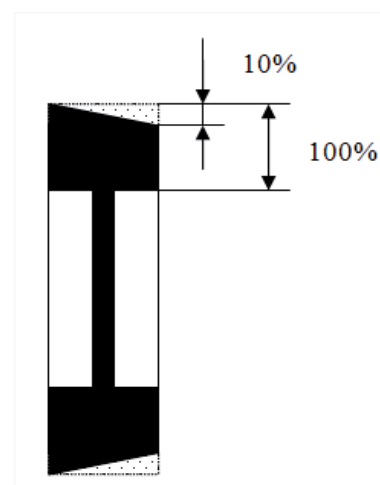

E - General Specifications

- 1 wheel stud is completely torn.
- 2 successive wheel studs are partially torn.
- 2 aperture holes are cut.

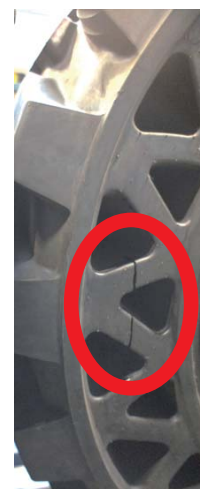

Tires and rims are critical components for the stability of the machine. For safety reasons :

- Use only HAULOTTE® spare parts according to the technical characteristics of the machine. Refer to the spare parts catalog.
- Do not replace factory-installed tires with tires of different specifications or ply rating.
- Never replace a solid (rigid) (Solid Tyre) tire with a foam-filled or a pneumatic (air-filled) tire.

Procedure of replacement :

- Loosen the wheel nuts on the wheel to be removed.
- Raise the machine using a jack or a hoist.
- Remove the wheel nuts.
- Remove the wheel.
- Install the new wheel.
- Check for correct wheel nut tightening sequence.
- Lower the machine to the ground.
- Tighten the wheel nuts to the recommended torque. Refer to maintenance and repair manuals.

N.B.-:IF A WHEEL HAS BEEN REPLACED, WHILE OBSERVING THE AXLE TRACK PATTERN CHECK FOR CORRECT INSTALLATION.

E - General Specifications

5 - Options

5.1 - ON-BOARD GENERATOR

5.1.1 - Principle

The on-board generator supplies voltage (220 V or 110 V depending; on the option) in the basket to connect a power tool.



Check that the maximum power of the tool doesn't exceed that of the generator.



Do not expose the on-board generator to direct contact with a water beam or a high pressure cleaner.

5.1.2 - Procedure

Put into service :

1. Start the machine. Heat the engine for 15 mn before any operation.
2. From the platform control box, move the generator selector switch ((79)) to the right to activate the generator
3. Connect the tool to the socket.
4. You can change the tool at any time.

N.B.-:WHEN USING THE ON-BOARD GENERATOR, YOU CANNOT MAKE ANY MACHINE MOVEMENTS. TO MAKE A MOVEMENT, YOU MUST SWITCH OFF THE ON-BOARD GENERATOR.

Power off :

5. Disconnect the tool from the socket.
6. From the platform control box, activate the selector switch (79) to the right to activate generator.
7. Machine movements are once again functional.

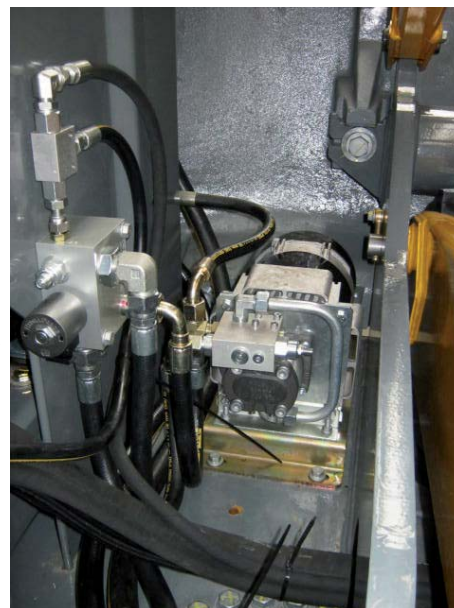

E - General Specifications

5.2 - GLAZIER'S KIT

5.2.1 - Description

This attachment is an assembly designed to transport panels. The assembly comprises of a tray that extends along the length of the floor. The panel(s) should be placed in the tray and secured to the guard rail with a strap (not supplied).

N.B.-:-THIS TRAY CAN BE USED ONLY WITH A SIDE ENTRY PLATFORM.

5.2.2 - Characteristics

Component	Characteristics
Maximum capacity	115 kg (220 lbs)
Weight of attachment	10 kg (22 lbs)
Maximum load surface	3 m ² (32 sq.ft)
Maximum allowable height of the panel	1,20 m (3 ft 11 in)
Maximum allowed wind	CE / AS : 12,5 ms - 45 km/h - 28 mph ANSI / CSA: 7 ms - 25 km/h - 15 mph

5.2.3 - Safety precautions



- Please read and assimilate the instructions before using the attachment.
- This attachment is designed for transporting panels. Do not use this attachment for transporting other types of load.
- Do not suspend loads.
- Do not overload the attachment and ensure that the equipment is correctly attached by means of a strap (not supplied).
- Do not exceed the maximum allowable platform capacity. The combined weight of the attachment, the panel(s), the occupants, the tools and any other equipment must not exceed the maximum allowable platform capacity.
- Do not load panels whose surface area exceeds the maximum authorized surface area. Exposing an additional surface area to the wind reduces machine stability. Do not install any other attachments that increase the surface area exposed to the wind.
- Check that the position of the panel is not reducing visibility during maneuvers in the work environment. Do not transport panels whose height exceeds the authorized limit.
- When maneuvering, ensure that a safe distance is maintained between the panel and the obstacles in the work environment.
- Do not use the machine if the wind speed exceeds the allowable limit with the attachment.

5.2.4 - Pre-operation inspection



- Check that the tray has no cracks or other damage.
- Check that the cradles are correctly installed and secured to the platform.
- Check that the information decal is present on the cradle and is legible.
- Check that the strap is not twisted or torn.

E - General Specifications

5.2.5 - Operation

- Load the panel onto the tray on platform.
- Secure the panel tray on the guardrail by means of a strap (not supplied) with the correct strength and dimensions.

Strapping example(s) - Large panel



Strapping example(s) - Small panel



E - General Specifications

5.2.6 - Assembly / Dis-assembly

Tray



Marking	Description
1	Tray (Panel carrier)
2	Platform
3	Screws and nuts
4	Collars COLSON
5	Plastic protection

- Fix the tray (1) to the platform (2) using screws and bolts (3)
- Install plastic protection (5) on the handrail and attach it using collars (4)

N.B.-:-TORQUE REQUIREMENTS : 22 N.M (16 LBS.FT)

- Pre-operation test : Place a load of 176 kg (388 lbs) on the carrier and carry out an inspection.  Pre-operation inspection (Above).

E - General Specifications

5.2.7 - Specific decals

Location of the decals

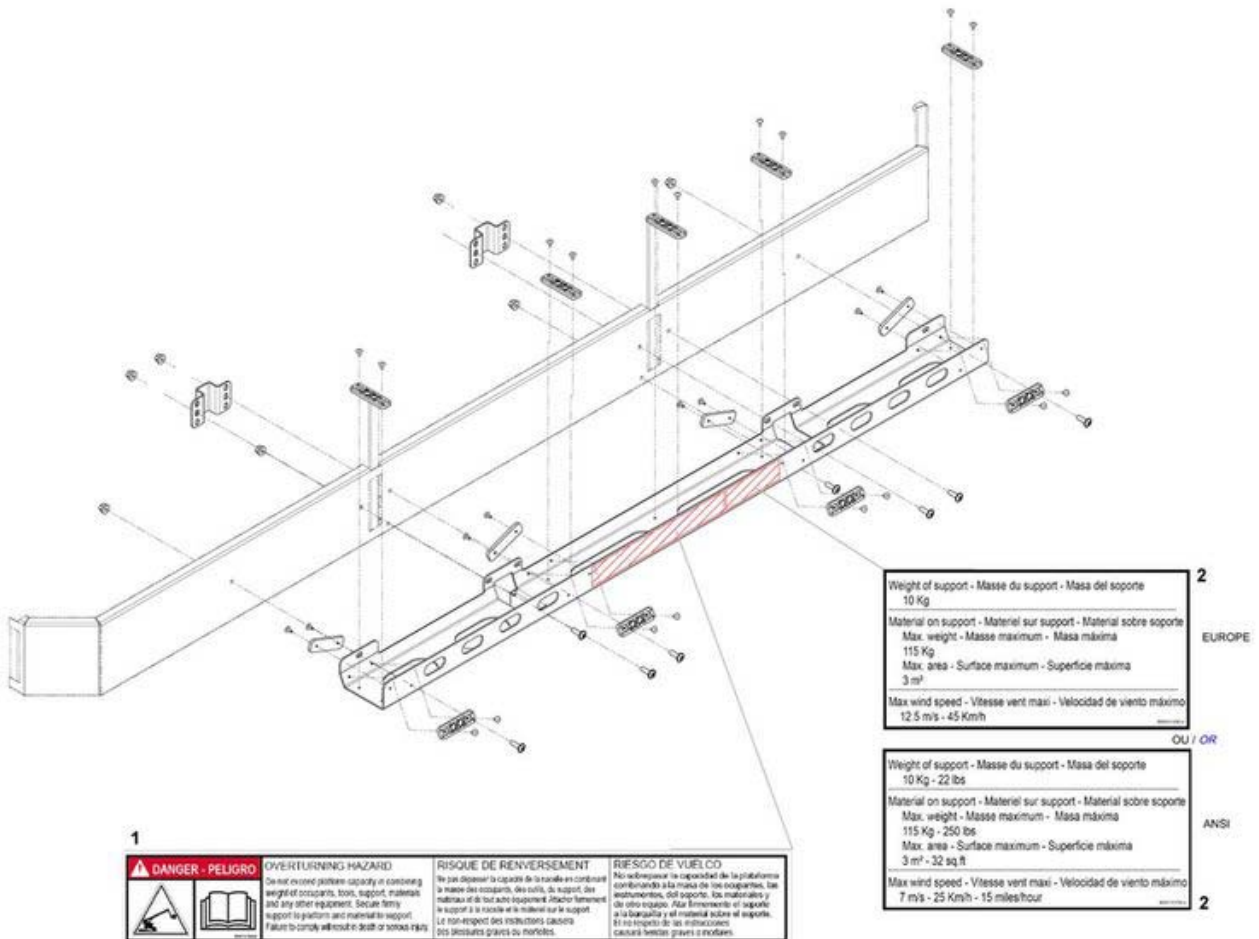

Marking	Description	Quantity	Part number
1	Risk of overturning	1	4000131830
2	Equipment characteristics	1	CE / AS : 4000131630 ANSI / CSA: 4000131730

E - General Specifications

5.3 - ACTIV' SHIELD BAR - SECONDARY GUARDING SYSTEM (IF FITTED)

5.3.1 - Description



General Specification Activ' Shield Bar :

- The Activ' Shield Bar is a device designed to reduce the risk of entrapment against the control panel when the platform is in confined spaces.
- This device is complementary to the existing operator protection including the enable switch system (Trigger of joystick, 'Enable switch' foot pedal and 'Enable switch' on ground control box).
- The Activ' Shield Bar is active when the platform is elevated (boom or arm) and creep speed is automatically engaged. It is not enabled when stationary or in the transport position, when drive, turret rotation and jib raise are possible.
- The green indicator light of the Activ' Shield Bar is illuminated indicating the device is active :
- Light flashing : Machine stationary in Activ' Shield Bar zone (The platform is elevated and the Activ' Shield Bar will be active during movements).
- Light on : Activ' Shield Bar is active.



This system does not relieve the operator from the responsibilities of learning and practicing the principles of safe use and operation of the machine as provided by the manufacturer's instructions, employer's safety rules and worksite regulations

5.3.2 - Characteristics

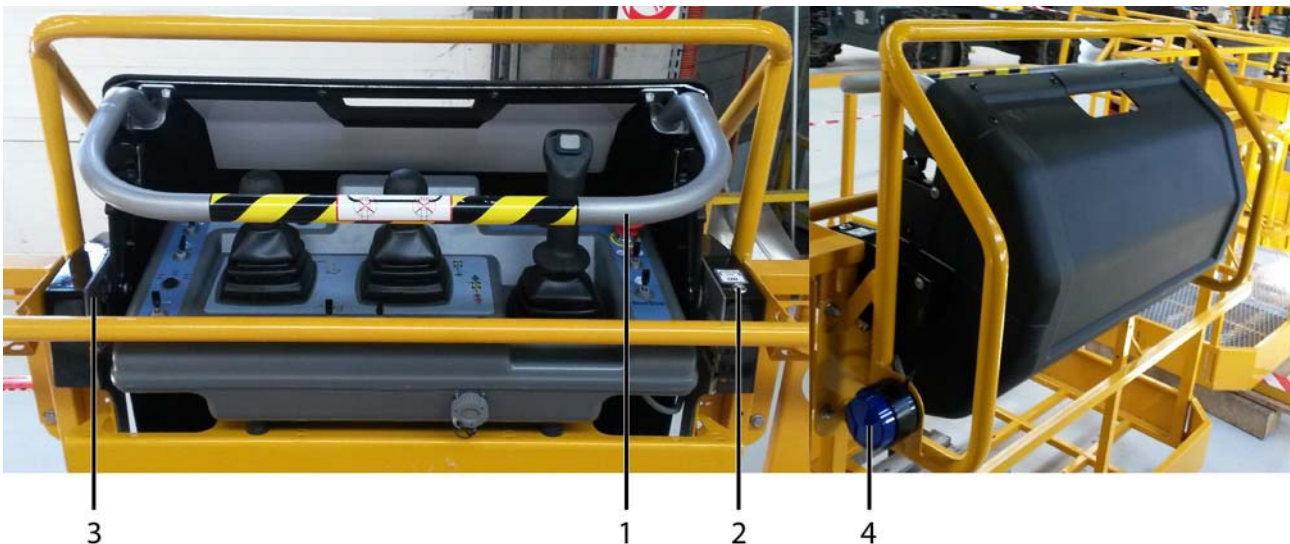

Marking	Description
1	Activation bar
2	Green indicator light
3	Sensor
4	Blue flashing light

E - General Specifications

5.3.3 - Safety precautions



It is mandatory to ensure that the **Activ' Shield Bar** is functional at each start-up of the machine



Do not use the **Activ' Shield Bar** as a handhold. This could result in an inadvertent triggering of the **Activ' Shield Bar**.

- Check the work area for overhead clearances, obstructions or other possible hazards.



- When driving, position the platform so as to provide the best visibility possible and avoid any blind spots.

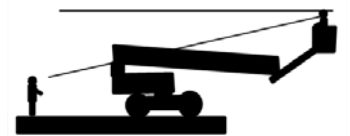

- Always ensure that the chassis is never driven any closer than 1 m (3 ft3 in) from holes, bumps, tilts, obstructions, debris and ground coverings that may hide dangers.
- During operation, keep all the parts of the body inside the platform.
- To position the machine close to obstacles, it is recommended to use boom movements (arm, boom, etc.) instead of the drive movements.
- Do not drive fast in narrow or cluttered areas. Keep speed under control while making turns or sharp bends.
- Do not use the **Activ' Shield Bar** as a handhold. To prevent unintentional activation of the system.

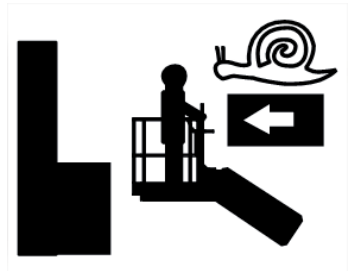

E - General Specifications

5.3.4 - Pre-operation inspection



- If any item on the checklist is marked NO during the inspection; machine must be tagged and locked out and placed out of service.
- DO NOT operate the machine until all identified items are corrected and it has been declared safe for operation.

Description	Yes	No
Perform all specified machine functional tests		
<ul style="list-style-type: none"> • All machine functional tests result positive 		
Start the machine from platform control box		
Switch off (pushed in) all E-Stop buttons		
<ul style="list-style-type: none"> • Check absence of warning signal • Check that the light indicator is not activated when the machine is in stowed position 		
To ensure Activ' Shield Bar device is functioning correctly, perform the following :		
When stowed :		
<ul style="list-style-type: none"> • Check that the green indicator light is not illuminated 		
When boom or arm is raised above 15° :		
<ul style="list-style-type: none"> • Check that the green indicator light is blinking-With platform stationary. • Check that the green indicator light is illuminated-With platform in motion. 		
Simultaneously make a movement and push forward the activation bar to trigger the system :		
<ul style="list-style-type: none"> • Check that all movements stop. • Check that the horn and the blue flashing light are activated. 		

N.B.-:-PRESS THE 'ENABLE SWITCH' FOOT PEDAL TO RESET THE SYSTEM

5.3.5 - Operation

If the Activ' Shield Bar is pushed forward, all movements are stopped. The horn sounds and the warning blue light flashes. Only movements to move away from the entrapment are authorised.

To re-set the Activ' Shield Bar, release the activation bar, the 'Enable switch' foot pedal and controls. Then, re-press the 'Enable switch' foot pedal.

Care must be taken during all operations to prevent collision and entrapment against structures.

E - General Specifications

5.3.6 - Specific decals

Location of the decals

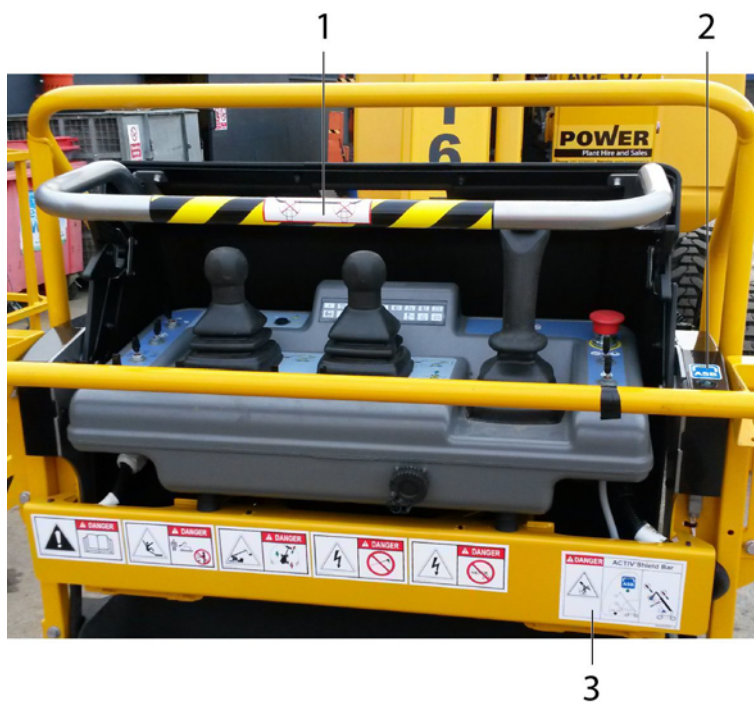

Marking	Description	Quantity	Part number
1	Do not lean on the bar	1	4000206690
2	Activ' Shield Bar active	1	4000596720
3	Activ' Shield Bar operating	1	4000609540

E - General Specifications

5.4 - SWING GATE

5.4.1 - Description

"SWING GATE" consists of a laterally mounted pivoting $\frac{1}{2}$ gate with closing latch, which enables a better access to platform. Swing Gate allows access to the platform. Spring loaded hinges and a latching mechanism allows the gate to swing inwards only.

Swing gate



E - General Specifications

5.4.2 - Characteristics

Width of the gate : 500 mm / 19.68 in

5.4.3 - Safety precautions



- The gate is part of the guardrail system and must be securely fastened after entering the platform.
- Pay attention to the toe board when entering or exiting the platform.

5.4.4 - Pre-operation instructions

- Inspect that the latching mechanism is securely fastened.
- Check the hinges and latch operate correctly and are not deformed.
- Ensure that the gate returns automatically to the closed and fastened position after entering or exiting the platform.

F - Maintenance

1 - General

As an owner and/or operator of Haulotte equipment, your Safety is of utmost importance to HAULOTTE®, which is why HAULOTTE® places such a high priority on product safety.

INSPECTIONS are not only required by HAULOTTE®, but may also be required by industry standards and/or governmental regulations.

To ensure that your equipment continues to perform to the factory set performance levels, it is important that you regularly maintain your equipment and avoid making any modifications that are not approved by HAULOTTE®. Regular and timely inspections will reduce equipment down time as well as prevent possible injury.

N.B.-:DO NOT OPERATE UNLESS YOU ARE FAMILIAR AND TRAINED IN THE PRINCIPLES OF SAFE MACHINE OPERATION.

Overview :

- Walk-around inspections take only a few minutes at the beginning and end of each shift – one of the best ways to prevent mechanical problems and safety hazards.

What to Do :

- Use your senses: sight, smell, hearing and touch.

Frequency :

- Check your machine periodically during your entire workday.
- Make sure to do your inspection the same way every time.
- Complete one of these inspections at the start and end of each shift.

N.B.-:IF DAMAGE OR UNAUTHORIZED MODIFICATIONS ARE DISCOVERED, THE MACHINE MUST BE REMOVED FROM SERVICE UNTIL REPAIRS ARE MADE BY A QUALIFIED SERVICE TECHNICIAN.

It is the owner's responsibility to ensure the required maintenance as recommended by Haulotte is completed prior to the operation of the machine.

If regular maintenance is not carried out, this may :

- Void the warranty.
- Cause machine malfunction.
- Reduce machine reliability and shorten its service life.
- Jeopardize operator safety.

HAULOTTE Services® technicians are specially trained to carry out extensive repairs, interventions or adjustments on the safety systems or elements of HAULOTTE® machines. They carry genuine HAULOTTE spare parts and tools as required, and also provide fully documented reports on all work completed.

The inspection and maintenance table, identifies the role and the responsibilities of each party in periodical machine maintenance.  Section C 4 Inspection and Functional test.

F - Maintenance

2 - Maintenance Schedule

This section provides the necessary information needed to place the machine in safe operation. For maximum service life and safe operation, ensure that all the necessary inspections and maintenance have been completed. There are a number of factors which can affect the design life including but not limited to, severity of operating conditions/routine maintenance which should be carried out in accordance with this manual.

Severity of operating conditions may require a reduction in time between maintenance periods. Machines that have been out of service for more than 3 months must undergo a periodic inspection before the machine is put back into service.

Maintenance must be carried out by a competent company or person familiar with mechanical procedures.

Maintenance operations performed must be recorded in a register / log book of the machine.

F - Maintenance

3 - Inspection program

3.1 - GENERAL PROGRAM

The machine must be inspected on a regular basis at intervals of no less than once 1 per year. The purpose of the inspection is to detect any defect which could lead to an accident during routine use of the machine. Local standards and regulations may require more frequent inspections.

HAULOTTE® requires Reinforced and Major Inspections to be carried out on the product to extend its service life.

Inspections must be carried out by a competent company or person.

The inspection results must be recorded in the safety register or machine log book controlled and overseen by the company manager. This register or machine log book and the list of competent repair persons must be made available to the government work inspector and HAULOTTE Services®.

When	Responsible	Stakeholder	What
Before sale	Owner (or renter)	Competent technician or qualified technician HAULOTTE Services®	Periodic inspection
Before rent	Owner (or renter)	Competent technician or qualified technician HAULOTTE Services®	Daily inspection
Before use or every change of user	User	User	
Annually (1 year)	Owner (or renter)	Competent technician or qualified technician HAULOTTE Services®	Periodic inspection
5 years	Owner (or renter)	Qualified technician HAULOTTE Services®	Reinforced inspection
10 years	Owner (or renter)	Qualified technician HAULOTTE Services®	Major inspection

3.2 - DAILY INSPECTION

The Daily inspection includes a visual inspection, operational checks and testing of the safety systems. This must be conducted by the operator before using the machine.

This inspection is the responsibility of the user.

Refer to Section C for Daily inspection procedures.

F - Maintenance

3.3 - PERIODIC INSPECTION

The Periodic inspection is a thorough evaluation of the operation and safety features of the machine.

It must be conducted before the sale / resale of the machine and/or at least once 1 every year.

Local regulations may have specific requirements on frequency, and content of inspections.

The severity of operating conditions may require frequent inspections.

This inspection is the responsibility of the owner, and inspections must be carried out by a competent company or person.

This inspection is in addition to the daily inspection.

This inspection should also be conducted after :

- Extensive dismantling and reassembly of major components.
- Repairs involving the machine's essential components.
- Any accident causing stress to the machine.

3.4 - REINFORCED INSPECTION

The Reinforced inspection is a thorough evaluation of the machine's structural components, to ensure proper functionality of the machine.

This evaluation must occur at a frequency of 5000 hours or every 5 years.

This inspection is the responsibility of the owner, and it must be conducted by a HAULOTTE Services® technician or by a competent company or person.

This inspection includes :

- Daily inspection
- Periodic inspection

N.B.-:REFER TO THE MAINTENANCE MANUAL FOR DETAILS.

3.5 - MAJOR INSPECTION

The Major inspection is a thorough evaluation of the machine's integrity and proper functioning; after a standard/normal working life of 10 years.

This evaluation must take place after 10 years of operation and then repeated every 5 years thereafter.

The severity of operating conditions may require frequent inspections.

This inspection is the responsibility of the owner, and it must be conducted by a HAULOTTE Services® technician.

This inspection includes :

- Daily inspection
- Periodic inspection
- Reinforced inspection

N.B.-:REFER TO THE MAINTENANCE MANUAL FOR DETAILS.

F - Maintenance

4 - Repairs and adjustments

Extensive repairs, interventions or adjustments on the safety systems or components must be performed by a HAULOTTE Services® technician. Use original spare parts and components only.

N.B.-: -HAULOTTE SERVICES® TECHNICIANS ARE TRAINED PROFESSIONALS TO PERFORM EXTENSIVE REPAIRS, INTERVENTIONS AND ADJUSTMENTS ON THE SAFETY SYSTEMS OR COMPONENTS OF HAULOTTE® MACHINES. THE TECHNICIAN CARRIES GENUINE HAULOTTE® SPARE PARTS AND TOOLS AS REQUIRED, AND ALSO PROVIDES FULLY DOCUMENTED REPORTS ON ALL WORK COMPLETED.

HAULOTTE Services® will not take responsibility for any outcomes resulting from inferior services or repairs performed by other unauthorised personnel.

HAULOTTE® reminds that NO modifications SHALL be carried out without the written permission of HAULOTTE®.

Any unauthorised repairs/modifications will void HAULOTTE® warranty.

With the utmost care to ensure enhanced reliability and greater safety of the HAULOTTE® products, it is pertinent that when a "Service or Safety Bulletin" is issued, action is taken immediately. Once the bulletin has been addressed, make sure that the completed form is submitted to HAULOTTE®.

N.B.-: -WHEN DISPOSING OR SCRAPPING THIS MACHINE, PLEASE CONSIDER APPROPRIATE METHODS OF RECYCLING. ANY ITEMS THAT REQUIRE SPECIFIC DISPOSAL ARE LISTED WITH INSTRUCTIONS IN THE MAINTENANCE MANUAL.

G - Other information

1 - Warranty disclosure

1.1 - AFTER SALES SERVICE

Our HAULOTTE Services® After Sales Service is at your disposal throughout your machine's service life to ensure the optimum use of your HAULOTTE product :

- When contacting our After Sales Service, ensure that you provide the machine model and serial number.
- When ordering any consumables or spare parts, please use this manual and the HAULOTTE® Essential catalogue to receive your genuine HAULOTTE® spare parts, your only guarantee of parts interchangeability and correct machine operation.
- If there is an equipment malfunction involving a HAULOTTE® product, then contact HAULOTTE Services® immediately even if the malfunction does not involve material and/or bodily damage.

1.2 - MANUFACTURER'S WARRANTY

1.2.1 - Warranty acceptance

On reception of his machine, the owner or rental company must check the machine's condition and fill out the machine reception slip provided.

1.2.2 - Warranty period

The present warranty is valid for a period of 12 months or up to a maximum of 1000 operating hours for lifting and handling equipment and 2000 operating hours for public works machinery, starting from delivery and terminating when the first limit is reached.

Spare parts are covered by a 6 month warranty.

1.2.3 - Procedure conditions

To benefit from the warranty, the owner or rental company must inform the nearest HAULOTTE® subsidiary or the subsidiary that delivered the machine (the only dealer authorised to carry out an intervention under the manufacturer's warranty agreement) of the defect in writing as quickly as possible.

The subsidiary will decide whether to repair or replace the part that proves to be faulty.

The owner or rental company must present the duly completed maintenance book supplied with the machine as proof that the maintenance operations recommended by the manufacturer have been carried out.

The owner or rental company must ensure that the defect covered by the HAULOTTE® warranty is reported to and acknowledged by the HAULOTTE® subsidiary as rapidly as possible or must report the defect in writing.

Work carried out under the HAULOTTE® warranty will be performed by the subsidiary which delivered the machine, wherever possible.

G - Other information

1.2.4 - Conditions of warranty

HAULOTTE® guarantees its products against defects, faults or manufacturing defects when the owner or rental company has informed HAULOTTE® of the defect.

The warranty does not cover the consequences of normal wear, nor any defects, failure or damage resulting from poor maintenance or abnormal usage, in particular overloading, impact by an external source, faulty installation or any modification made to products marketed by HAULOTTE® and performed by the owner or rental company.

In the event of operation or use which does not comply with the instructions or recommendations in the maintenance book, warranty claims will not be accepted.

The machine utilisation period must be recorded by reading the engine hour meter whenever an intervention is made. The engine hour meter must be maintained in good working order to guarantee maximum working life and to justify maintenance at the recommended time.

Warranty obligations for the time period stated above will cease immediately in situations where the defect is due to the following reasons :

- Use of spare parts that are not HAULOTTE® originals.
- If elements or products other than those recommended by the manufacturer are used.
- If the HAULOTTE® name, serial numbers or identification marks are removed or altered.
- After an unreasonably long delay before reporting a manufacturing problem.
- If the owner or rental company continues to use the machine despite problems.
- If damage is caused by modifications that do not comply with HAULOTTE® specifications.
- If lubricants, hydraulic oils or fuels that do not comply with HAULOTTE® recommendations are used.
- If the machine is incorrectly repaired or used by the customer.
- In case of an accident caused by a third party.

G - Other information

If no particular agreement has been made, any claims made after the previously established warranty period has expired will be refused.

The present warranty does not cover damage that may result directly or indirectly from any flaws or defects covered by the latter :

- Consumables : No claims will be accepted for objects or parts replaced in the context of normal machine usage.
- Settings : Adjustments of all sorts may become necessary at any time. Therefore adjustments are considered a part of normal machine usage conditions and are not covered by the warranty.
- Hydraulic and fuel circuit contamination : Every possible precaution is taken to ensure that fuel and hydraulic liquid delivered is clean. HAULOTTE® will not accept any claims concerning cleaning of the fuel circuit, filter, injection pump or any other equipment in direct contact with fuel or lubricants.
- Wearing parts (pads, bearings, tires/tyres, connections, etc.) : These parts are, by definition, subject to deterioration during the period of operation. Wearing parts will therefore not be covered by the warranty agreement.

A

B

C

D

E

F

G

H

I

G - Other information

2 - Subsidiary contact information

	<p>HAULOTTE FRANCE PARC DES LUMIERES 601 RUE NICEPHORE NIEPCE 69800 SAINT-PRIEST TECHNICAL Department: +33 (0)820 200 089 SPARE PARTS : +33 (0)820 205 344 FAX : +33 (0)4 72 88 01 43 E-mail : haulottefrance@haulotte.com www.haulotte.fr</p>		<p>HAULOTTE ITALIA VIA LOMBARDIA 15 20098 SAN GIULIANO MILANESE (MI) TEL: +39 02 98 97 01 FAX: +39 02 9897 01 25 E-mail : haulotteitalia@haulotte.com www.haulotte.it</p>		<p>HAULOTTE INDIA Unit No. 1205, 12th floor, Bhumiraj Costarica, Plot No. 1&2, Sector 18, Palm Beach Road, Sanpada, Navi Mumbai- 400 705 Maharashtra, INDIA Tel. : +91 22 66739531 to 35 E-mail : sray@haulotte.com www.haulotte.in</p>
	<p>HAULOTTE HUBARBEITSBÜHNEN GmbH Ehrenkirchener Strasse 2 D-79427 ESCHBACH TEL : +49 (0) 7634 50 67 - 0 FAX : +49 (0) 7634 50 67 - 119 E-mail : haulotte@de.haulotte.com www.haulotte.de</p>		<p>HAULOTTE VOSTOK 61A, RYABINOVAYA STREET Bldg. 3 121471 MOSCOW RUSSIA TEL/FAX : +7 495 221 53 02 / 03 E-mail : info@haulottevostok.ru www.haulotte-international.com</p>		<p>HAULOTTE DO BRASIL AV. Tucunaré, 790 CEP: 06460-020 – TAMBORÉ BARUERI – SAO PAULO – BRASIL TEL : +55 11 4196 4300 FAX : +55 11 4196 4316 E-mail : haulotte@haulotte.com.br www.haulotte.com.br</p>
	<p>HAULOTTE IBERICA C/ARGENTINA Nº 13 - P.I. LA GARENA 28806 ALCALA DE HENARES MADRID TEL : +34 902 886 455 TEL SAT : +34 902 886 444 FAX : +34 911 341 844 E-mail : iberica@haulotte.com www.haulotte.es</p>		<p>HAULOTTE POLSKA Sp. z o.o. UL. GRANICZNA 22 05-090 RASZYN - JANKI TEL : +48 22 720 08 80 FAX : +48 22 720 35 06 E-mail : haulottepolska@haulotte.com www.haulotte.pl</p>		<p>HAULOTTE MÉXICO, Sa de Cv Calle 9 Este, Lote 18, Civac, Jiutepec, Morelos CP 62500 Cuernavaca México TEL : +52 77 7321 7923 FAX : +52 77 7516 8234 E-mail : haulotte.mexico@haulotte.com www.haulotte-international.com</p>
	<p>HAULOTTE PORTUGAL ESTRADA NACIONAL NUM. 10 KM. 140 – LETRA K 2695 - 066 BOBADELA LRS TEL : + 351 21 995 98 10 FAX : + 351 21 995 98 19 E-mail : haulotteportugal@haulotte.com www.haulotte.es</p>		<p>HAULOTTE SINGAPORE Pte Ltd. No.26 CHANGI NORTH WAY, SINGAPORE 498812 Parts and service Hotline: +65 6546 6150 FAX : +65 6536 3969 E-mail : haulotteasia@haulotte.com www.haulotte.sg</p>		<p>HAULOTTE MIDDLE EAST FZE PO BOX 293881 Dubai Airport Free Zone DUBAÏ United Arab Emirates TEL : +971 (0)4 299 77 35 FAX : +971 (0) 4 299 60 28 E-mail : haulottemiddle-east@haulotte.com www.haulotte-international.com</p>
	<p>HAULOTTE SCANDINAVIA AB Talgårdsgatan 12 431 53 Mölndal SWEDEN TEL : +46 31 744 32 90 FAX : +46 31 744 32 99 E-mail : info@se.haulotte.com spar@se.haulotte.com www.haulotte.se</p>		<p>HAULOTTE TRADING (SHANGHAI) Co. Ltd. #7 WORKSHOP No 191 HUA JIN ROAD MIN HANG DISTRICT SHANGHAI 201108 CHINA TEL : +86 21 6442 6610 FAX : +86 21 6442 6619 E-mail : haulotteshanghai@haulotte.com www.haulotte.cn</p>		<p>HAULOTTE ARGENTINA Ruta Panamericana Km. 34,300 (Ramal A Escobar) 1615 Gran Bourg (Provincia de Buenos Aires) Argentina TEL.: +54 33 27 445991 FAX. +54 33 27 452191 E-mail : haulotteargentina@haulotte.com www.haulotte-international.com</p>
	<p>HAULOTTE UK Ltd STAFFORD PARK 6 TELFORD - SHROPSHIRE TF3 3AT TEL : +44 (0)1952 292753 FAX : + 44 (0)1952 292758 E-mail : salesuk@haulotte.com www.haulotte.co.uk</p>		<p>HAULOTTE GROUP / BILJAX 125 TAYLOR PARKWAY ARCHBOLD, OH 43502 – USA TEL : +1 419 445 8915 FAX : +1 419 445 0367 Toll free : +1 800 537 0540 E-mail : sales@us.haulotte.com www.haulotte-usa.com</p>		<p>HAULOTTE NORTH AMERICA 3409 Chandler Creek Rd. VIRGINIA BEACH, VA 23453 – USA TEL : +1 757 689 2146 FAX : +1 757 689 2175 Toll free : +1 800 537 0540 E-mail : sales@us.haulotte.com www.haulotte-usa.com</p>
	<p>HAULOTTE NETHERLANDS BV Koopvaardijweg 26 4906 CV OOSTERHOUT - Nederland TEL : +31 (0) 162 670 707 FAX : +31 (0) 162 670 710 E-mail info@haulotte.nl</p>		<p>HAULOTTE AUSTRALIA PTY Ltd 46 GREENS ROAD DANDENONG – VIC – 3175 TEL : 1 300 207 683 FAX : +61 (0)3 9792 1011 E-mail : sales@haulotte.com.au</p>		<p>HAULOTTE CHILE El Arroyo 840 Lampa (9380000) Santiago (RM) TEL : + 562 2 3727630 E-mail : haulotte-chile@haulotte.com www.haulotte-chile.com</p>

G - Other information

For the engine powered machines destined to the US market (Standards ANSI and CSA)

CALIFORNIA

Proposition 65 Warning

Diesel engine exhaust and some of its constituents are known to the state of California to cause cancer, birth defects, and other reproductive harm

A

B

C

D

E

F

G

H

I

